

DE Montageanleitung

EN Mounting instruction

ES Instrucciones de instalación

FR Instructions d'installation

IT Istruzioni per l'installazione

NL Montagehandleiding

CS Návod k instalaci

PL Instrukcja montażu

RU Инструкция по монтажу

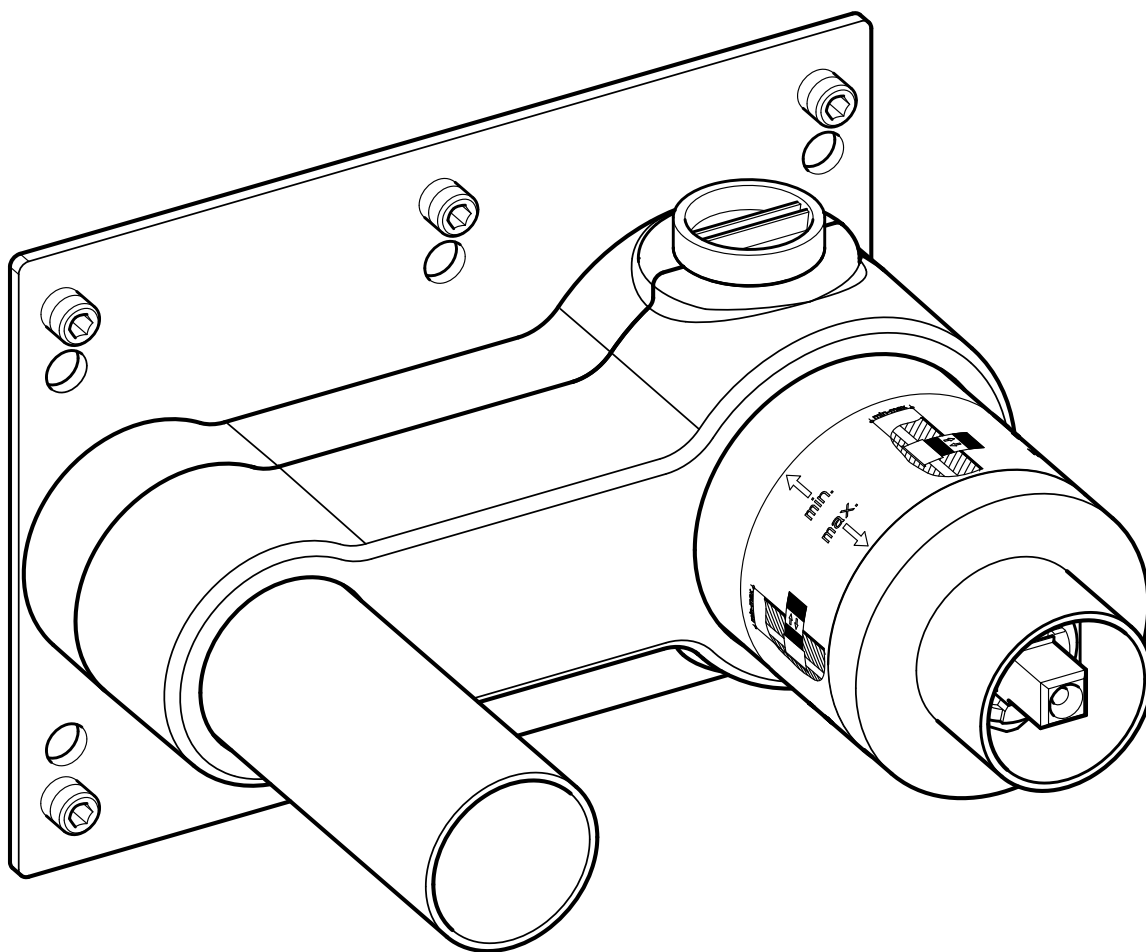

59916 000070

DE Einbaumaße

FR Dimensions de montage

CS Montážní rozměry

EN Mounting dimensions

IT Dimensioni di montaggio

PL Wymiary montażowe

ES Dimensiones de montaje

NL Montageafmetingen

RU Установочные размеры

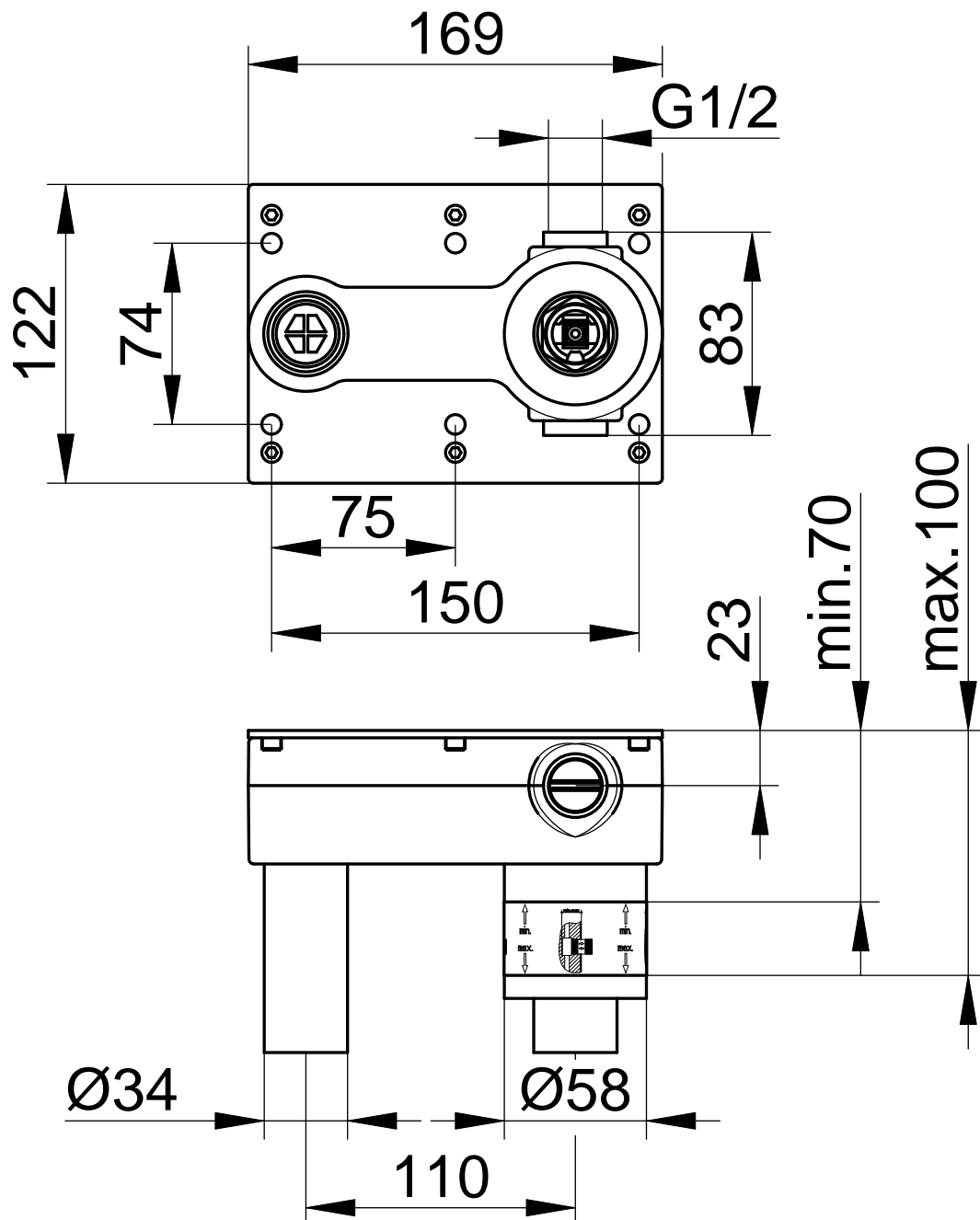



59916 000070

Symbole und Bedeutung

-  **Achtung!** Warnung vor Personen- oder Sachschaden.
-  **Achtung!** Warnung vor Stromschlag.
-  **Achtung!** Warnung vor Wasserschaden.
-  Hinweis, Tipp oder Verweis
-  Korrekte Montage/Funktionsprüfung
-  Falsche Montage
-  Kaltwasser
-  Warmwasser
-  Wasserfluss
-  Kein Wasserfluss
-  Optional/Zubehör

Verwendungszweck

-  Einhebelmischer für die Verwendung in Badezimmer und WC. Betrieb mit Druckspeichern, thermisch- und hydraulisch gesteuerten Durchlauferhitzern möglich. Betrieb mit drucklosen Speichern (offenen Warmwasserbereitern) **nicht** möglich!
- Betrieb nur mit Wasser in Trinkwasserqualität.
-  Produkt ausschließlich zur Montage in Innenräumen geeignet!
-  **Achtung!** Installation nur in frostfreien Räumen.

Technische Daten

- Fließdruck: min. 0,5 bar/empfohlen 1-5 bar
 - Betriebsdruck: max. 10 bar
 - Prüfdruck: 16 bar
 - Empfohlene Warmwassereingangstemperatur: max. 65° C
 - Wasseranschluss: kalt = Kennzeichnung blau
warm = Kennzeichnung rot
- Druckdifferenzen zwischen Kalt- und Warmwasserzuleitungen vermeiden.
Bei Ruhedrücken über 5 bar Druckminderer einbauen.











Einbaumaße, siehe Seite 2.

Installation, siehe ab Bild 1 auf Seite 8.



-  Trinkwasserleitungen vor und nach der Installation gründlich spülen (EN 806 und 1717 sowie DIN 1988 beachten).
- Anschlüsse mit hydraulischem Druck auf Dichtheit prüfen.

Ersatzteile mit Bestellnummern, siehe Seite 11.

Symbols and explanations

-  **Attention!** Warning against bodily injury or damage to property.
-  **Attention** Warning against electric shock.
-  **Attention!** Warning against water damage.
-  Note, tip or reference
-  Correct installation/test of functionality
-  Incorrect installation
-  Cold water
-  Hot water
-  Water flow
-  No water flow
-  Optional/accessories

Intended use

-  Single lever mixer tap for use in bathrooms and WCs. Operation possible with pressure tanks and thermally and hydraulically controlled instantaneous water heaters. Operation with unpressurised tanks (open water heaters) is **not** possible!
- Operation only with potable water.
-  Product is only suitable for installation indoors!
-  **Attention!** Only install in frost-free places.

Technical specifications

- Pressure: min. 0,5 bar/recommended 1-5 bar
 - Operating pressure: max. 10 bar
 - Test pressure: 16 bar
 - Recommended hot water inlet temperature: max. 65° C
 - Water connection: cold = blue marking
hot = red marking
- Avoid pressure differences between the cold and hot water feeds.
Install a pressure reducer for static pressures above 5 bar.











Installation dimensions, refer to page 2

Installation, refer to picture 1 on page 8



-  Flush potable water pipes thoroughly before and after installation (observe EN 806 and 1717).
- Test connections for leaks with water pressure.

For spare parts with order numbers, refer to page 11.

Símbolos y significado

-  ¡Atención! Advertencia de daños personales o materiales.
-  ¡Atención! Advertencia de descarga eléctrica.
-  ¡Atención! Advertencia de daños a causa del agua.
-  Indicación, consejo o referencia
-  Montaje/comprobación de funcionamiento correctos
-  Montaje erróneo
-  Agua fría
-  Agua caliente
-  Flujo de agua
-  Ningún flujo de agua
-  Opcional/Accesorios

Uso previsto

-  Mezclador monomando para la utilización en el baño y en el WC. Es posible el funcionamiento con acumuladores de presión, calentadores de agua instantáneos controlados térmica e hidráulicamente. **¡No** es posible el funcionamiento con acumuladores sin presión (calentadores de agua abiertos)!
Funcionamiento sólo con agua en calidad de agua potable.
-  ¡Producto adecuado exclusivamente para el montaje en interiores!
-  ¡Atención! Instalación exclusivamente en espacios sin riesgo de heladas.

Datos técnicos

- Presión de caudal: mín. 0,5 bares / recomendado 1-5 bares
- Presión de servicio: máx. 10 bares
- Presión de comprobación: 16 bares
- Temperatura de entrada de agua recomendada: máx. 65° C
- Conexión de agua: fría = identificación azul
caliente = identificación roja

Evitar las diferencias de presión entre las tuberías de agua fría y caliente.
En caso de presiones estáticas superiores a 5 bares, montar reductor de presión.











Medidas de montaje, véase página 2

Instalación, véase imagen 1 en la página 8



-  Lavar minuciosamente las tuberías de agua potable antes y después de la instalación (observar EN 806 y 1717).
Comprobar la estanqueidad de las conexiones con presión hidráulica.

Piezas de recambio con números de pedido, véase página 11.

Symboles et leur signification

-  **Attention !** Mise en garde contre les dégâts de personnes et les dégâts matériels.
-  **Attention !** Mise en garde contre les chocs électriques.
-  **Attention !** Mise en garde contre les endommagements par l'eau.
-  Remarque, conseil ou renvoi
-  Montage correct/contrôle fonctionnel
-  Montage incorrect
-  Eau froide
-  Eau chaude
-  Débit d'eau
-  Pas de débit d'eau
-  Option/accessoires

Domaine d'utilisation

-  Mitigeur monocommande pour utilisation dans la salle de bains et les WC. Utilisation possible avec accumulateurs de pression, réchauffeurs à circulation à commande thermique et hydraulique. Utilisation avec accumulateurs sans pression (chauffe-eau ouverts) **impossible !**
Utilisation seulement avec eau de qualité eau potable.
-  Le produit ne convient que pour un montage à l'intérieur !
-  **Attention !** Installation uniquement dans des pièces à l'abri du gel.

Caractéristiques techniques

- Pression d'écoulement : min. 0,5 bar/pression conseillée 1-5 bar
- Pression de service : max. 10 bar
- Pression de contrôle : 16 bar
- Température d'entrée d'eau chaude conseillée : max. 65° C
- Raccordement d'eau : froide = identification en bleu
chaude = identification en rouge

Éviter les différences de pression entre conduite d'arrivée eau froide et conduite d'arrivée eau chaude.
Pour des pressions de repos supérieures à 5 bar, monter un détendeur.





Cotes d'encombrement, voir page 2

Installation, voir figure 1 à la page 8



-  Rincer soigneusement les conduites d'eau potable avant et après l'installation (respecter les normes EN 806 et 1717).
Vérifier l'étanchéité des raccords à la pression hydraulique.

Pièces de rechange avec numéros de commande, voir page 11.

Simboli e significato

-  **Attenzione!** Pericolo di lesioni o danni materiali.
-  **Attenzione!** Pericolo di folgorazione.
-  **Attenzione!** Pericolo di danni causati dall'acqua.
-  Avvertenza, consiglio o rimando
-  Montaggio corretto/verifica del funzionamento
-  Montaggio errato
-  Acqua fredda
-  Acqua calda
-  Flusso d'acqua
-  Nessun flusso d'acqua
-  Opzionale/accessorio

Scopo d'uso

-  Miscelatore monocomando per l'utilizzo in bagno e WC. Possibilità di funzionamento con accumulatori di pressione, riscaldatori istantanei a controllo termico o idraulico. Funzionamento con accumulatori senza pressione (boiler con camera aperta) **non** possibile!
Funzionamento solo con acqua potabile.
-  Prodotto adatto esclusivamente per il montaggio in ambienti interni!
-  **Attenzione!** Installazione solo in ambienti in assenza di gelo.

Dati tecnici

- Pressione di flusso:
min. 0,5 bar/raccomandati 1-5 bar
- Pressione di esercizio: max. 10 bar
- Pressione di prova: 16 bar
- Temperatura d'ingresso dell'acqua calda consigliata: max. 65°C
- Collegamento dell'acqua:
fredda = marcatura blu
calda = marcatura rossa

Evitare differenze di pressione tra condotta di mandata dell'acqua fredda e calda.
Per pressioni statiche superiori a 5 bar installare un riduttore di pressione.

Ingombro, vedi pagina 2

Installazione, vedi dalla figura 1 a pagina 8



-  Prima e dopo l'installazione lavare con acqua abbondante le condotte di acqua potabile (osservare EN 806 e 1717).
Verificare la tenuta degli attacchi con pressione idraulica.

Ricambi con numero d'ordine, vedi pagina 11.

Symbolen en betekenis

-  **Opgepast!** Gevaar voor letsel of schade.
-  **Opgepast!** Gevaar voor elektrische schok.
-  **Opgepast!** Gevaar voor waterschade.
-  Opmerking, tip of referentie
-  Correcte montage/werkingstest
-  Verkeerde montage
-  Koud water
-  Heet water
-  Waterstroom
-  Geen waterstroom
-  Optioneel/toebehoren

Bestemd gebruik

-  Eenhendelmengkraan voor gebruik in badkamer en wc. Bedrijf met drukluchtreservoirs, thermisch en hydraulisch aangestuurde continuverwarmers mogelijk. Bedrijf met drukloze reservoirs (open heetwatertoestellen) **niet** mogelijk!
Gebruik uitsluitend met water van drinkwaterkwaliteit.
-  Het product mag alleen binnenshuis worden gemonteerd!
-  **Opgepast!** Installatie alleen in vorstvrije ruimten.

Technische gegevens

- Stromingsdruk: min. 0,5 bar/aanbevolen 1-5 bar
- Bedrijfsdruk: max. 10 bar
- Testdruk: 16 bar
- Aanbevolen ingangstemperatuur heet water max. 65° C
- Wateraansluiting:
koud = markering blauw
heet = markering rood

Drukverschillen tussen toevoerleidingen voor koud en heet water vermijden.
Bij statische druk van meer dan 5 bar drukverlagers inbouwen.











Inbouwafmetingen, zie pagina 2

Installatie, zie vanaf afbeelding 1 op pagina 8

-  Drinkwaterleidingen voor en na de installatie grondig spoelen (volgens EN 806 en 1717).
Aansluitingen met hydraulische druk controleren op lektheid.

Wisselstukken met bestelnummers, zie pagina 11.

Symbole a význam

-  **Pozor!** Výstraha před zraněním a věcnými škodami.
-  **Pozor!** Výstraha před úrazem elektrickým proudem.
-  **Pozor!** Výstraha před poškozením vodou.
-  Upozornění, tip nebo odkaz
-  Správná montáž / kontrola funkčnosti
-  Nesprávná montáž
-  Studená voda
-  Teplá voda
-  Průtok vody
-  Žádný průtok vody
-  Volitelná výbava / příslušenství

Účel použití

-  Páková směšovací armatura pro použití v koupelnách a WC. Provoz s tlakovými zásobníky, tepelně a hydraulicky řízenými průtokovými ohřivači možný. Provoz s beztlakovými zásobníky (otevřené ohřivače vody) **není** možný!

Provoz pouze s pitnou vodou.

-  Výrobek je vhodný výhradně k montáži ve vnitřních prostorách!

-  **Pozor!** Instalace v prostorách, které nepromrzají.

Technické údaje

- Průtokový tlak: min. 0,5 bar/doporučeno 1-5 bar
- Provozní tlak: max. 10 bar
- Zkušební tlak: 16 bar
- Doporučená teplota vstupní teplé vody: max. 65° C
- Příklad:
 - studená = označená modrou barvou
 - teplá = označená červenou barvou

Vyvarujte se rozdílu tlaku mezi přírodním potrubím teplé a studené vody. U klidového tlaku na 5 barů nainstalujte redukční ventil.





Montážní rozměry viz strana 2

Instalace viz obrázek 1 na straně 8

-  Potrubí na pitnou vodu před a po instalaci důkladně vypláchněte (postupujte podle EN 806 a 1717). Těsnost přípojek zkontrolujte hydraulickým tlakem.

Náhradní díly s objednávkami čísla viz strany 11.

Symbole i znaczenie

-  **Uwaga!** Ostrzeżenie przed szkodami osobowymi i materialnymi.
-  **Uwaga!** Ostrzeżenie przed porażeniem prądem elektrycznym.
-  **Uwaga!** Ostrzeżenie przed szkodami, spowodowanymi przez wodę.
-  Informacja, dobra rada lub odsyłacz
-  Właściwy montaż / kontrola funkcjonowania
-  Niewłaściwy montaż
-  Woda zimna
-  Woda gorąca
-  Strumień wody
-  Brak strumienia wody
-  Opcje / Osprzęt

Przeznaczenie

-  Bateria jednocyfrowa do stosowania w łazienkach i WC. Możliwa eksploatacja przy współpracy ze zbiornikami ciśnieniowymi lub podgrzewaczami przepływowymi, sterowanymi termicznie lub hydraulicznie. Eksploatacja przy współpracy ze zbiornikami bezciśnieniowymi (otwartymi podgrzewaczami wody) **nie** jest możliwa!

Możliwa eksploatacja w instalacji wody, zapewniającej jakość typową dla wody pitnej.

-  Produkt przeznaczony jest wyłącznie do montażu wewnątrz budynków!

-  **Uwaga!** Instalacja wyłącznie w pomieszczeniach, w których temperatura nie spada poniżej zera.

Dane techniczne

- Ciśnienie hydrauliczne: min. 0,5 bar/zalecane 1-5 bar
- Ciśnienie robocze: maks. 10 bar
- Ciśnienie kontrolne: 16 bar
- Zalecana temperatura wody gorącej na wejściu: maks. 65° C
- Przyłącze wody:
 - zimna = oznaczenie niebieskie
 - gorąca = oznaczenie czerwone

Należy unikać różnic ciśnień w przewodach doprowadzających ciepłą i zimną wodę. W przypadku ciśnienia spoczynkowego ponad 5 bar należy zbudować reduktor ciśnienia.

Wymiary zabudowy, patrz strona 2

Instalacja, patrz rys. 1 na stronie 8

-  Przed instalacją i po instalacji należy gruntownie przepłukać przewody, prowadzące wodę pitną (należy stosować się do EN 806 i 1717). Sprawdzić przyłącza ciśnieniem hydraulicznym w celu potwierdzenia ich szczelności.

Części zamienne z numerami zamówienia, patrz strona 11.

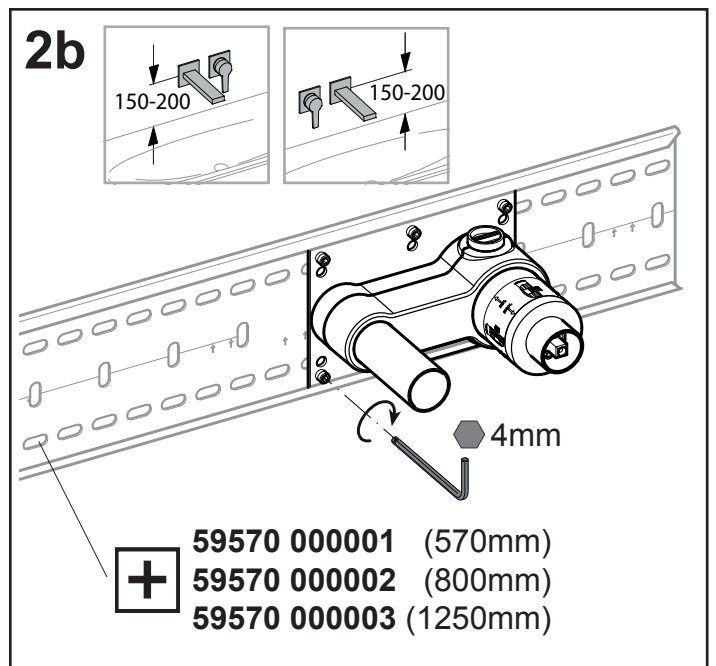
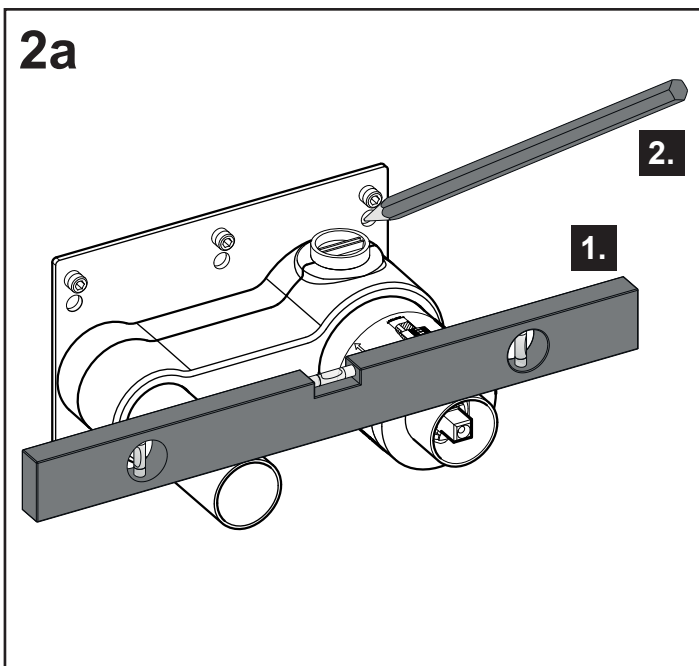
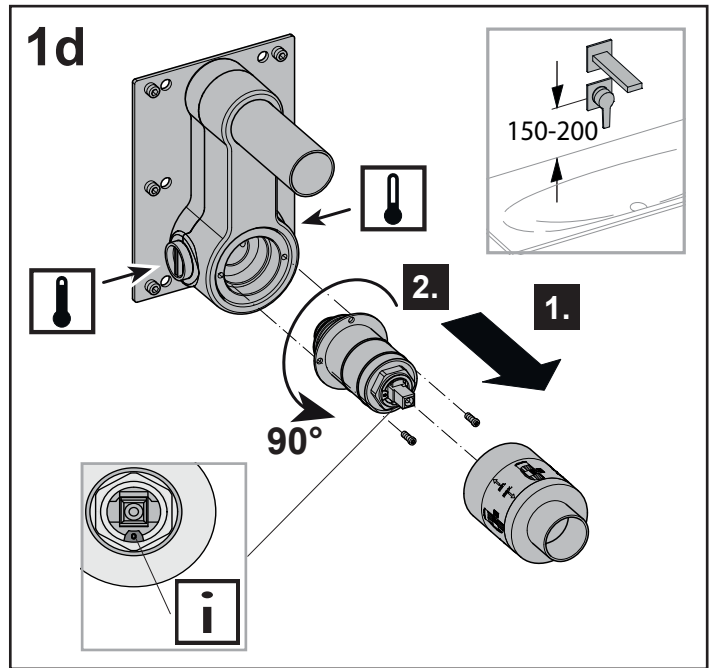
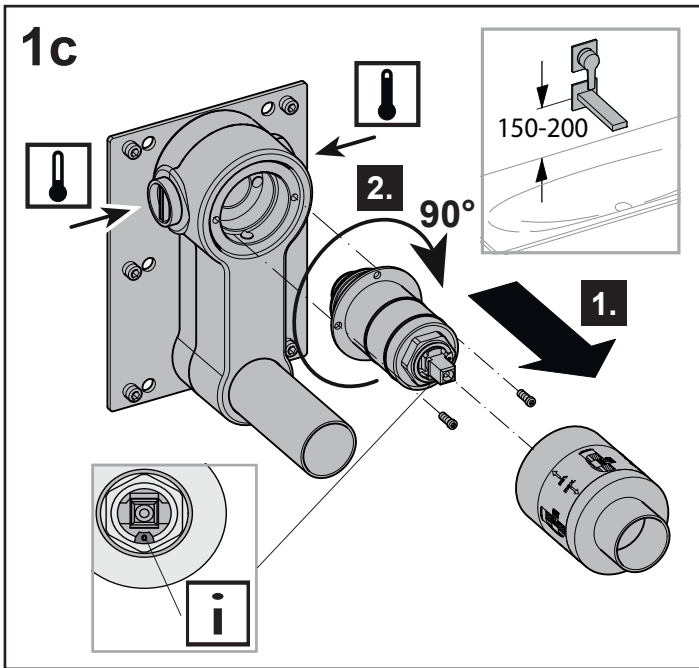
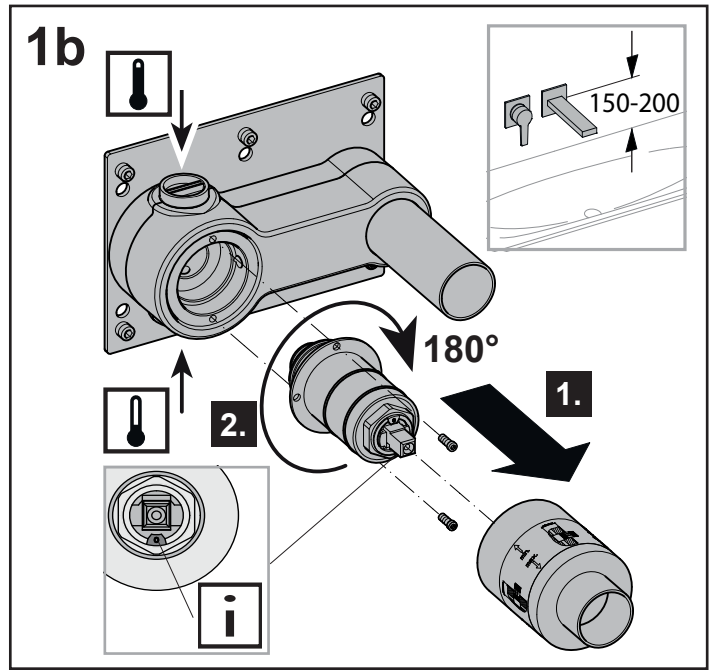
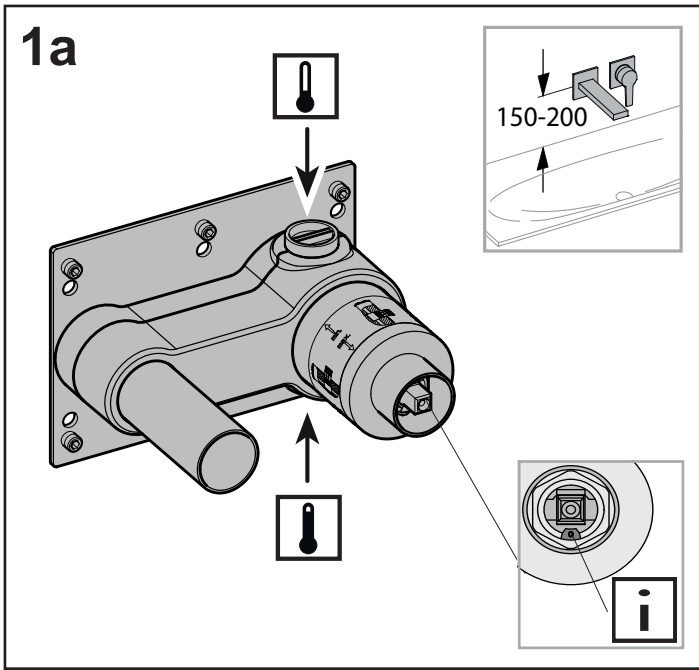

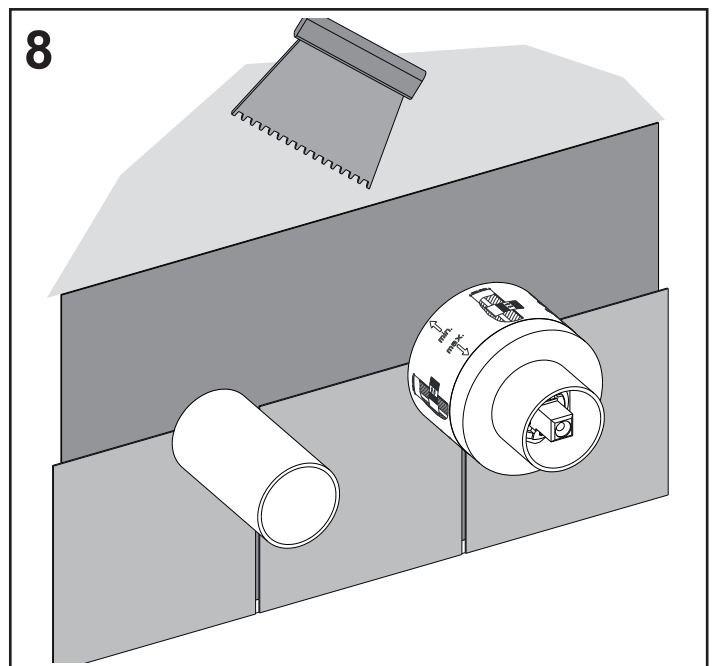
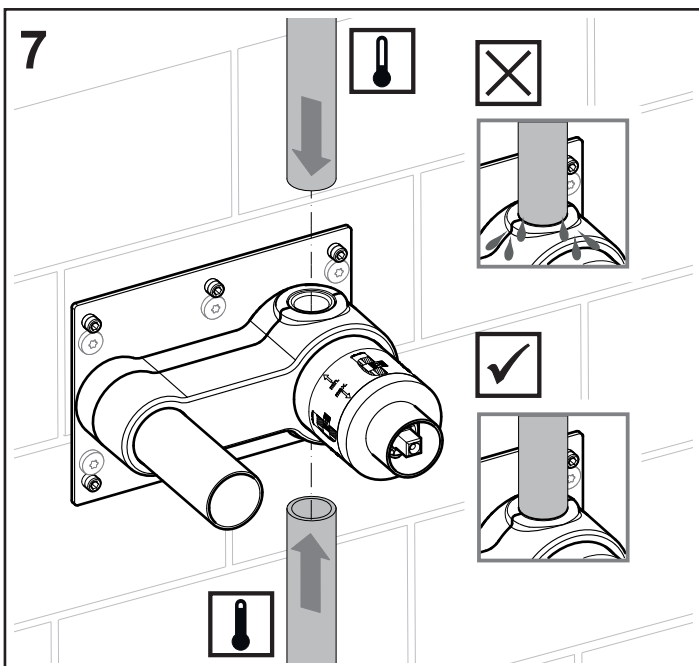
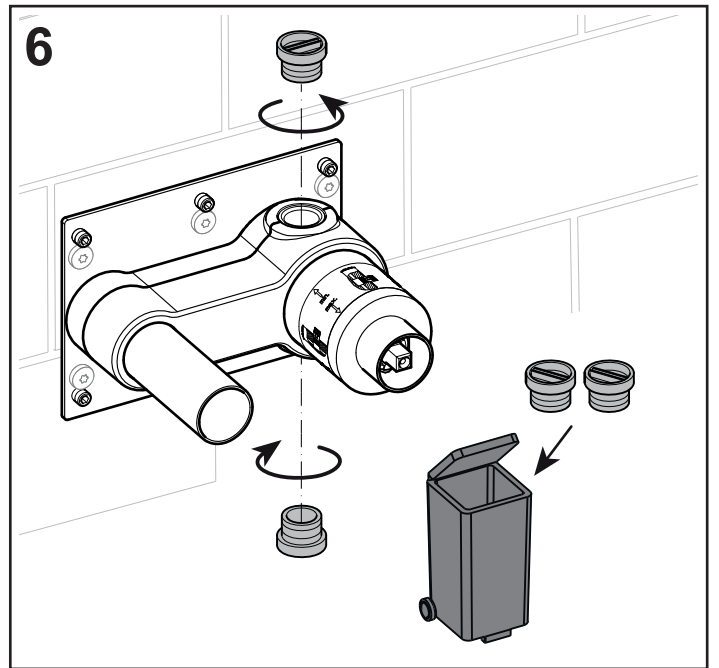
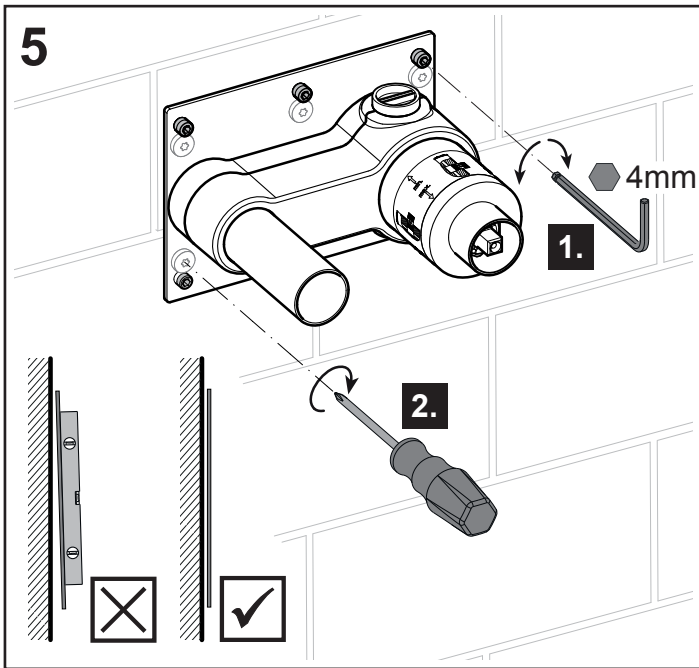
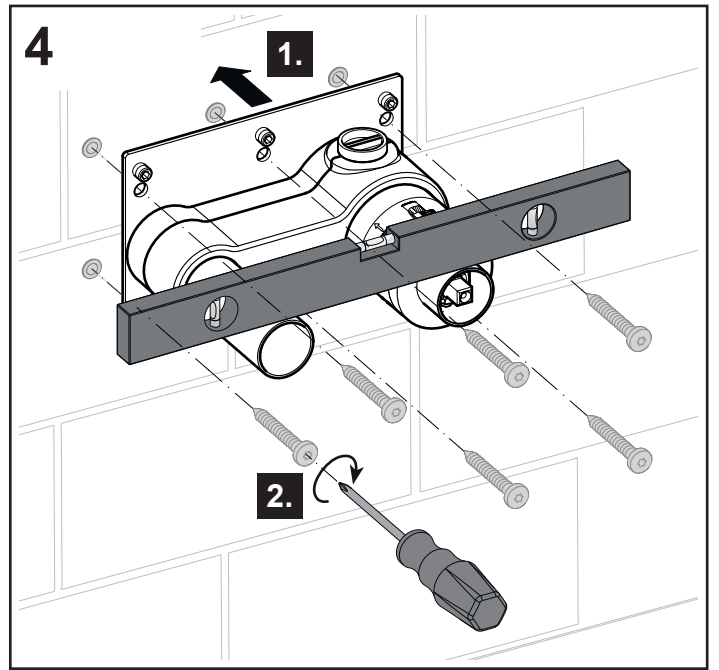
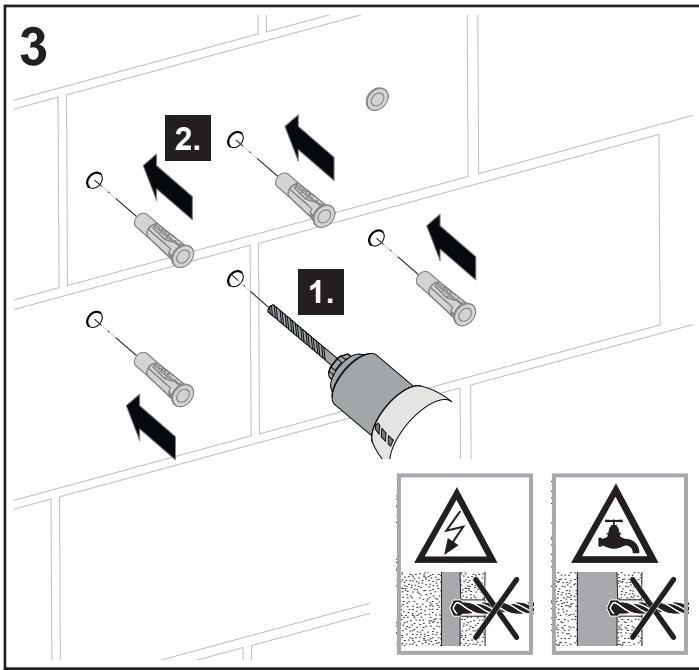



A series of 20 horizontal lines for writing, spaced evenly down the page.

DE Ersatzteile

FR Liste de pièces

CS Sada náhradních

EN Spare parts

IT Elenco delle parti

PL Zestaw części

ES Piezas de recambio

NL Onderdelen

RU Запчасти

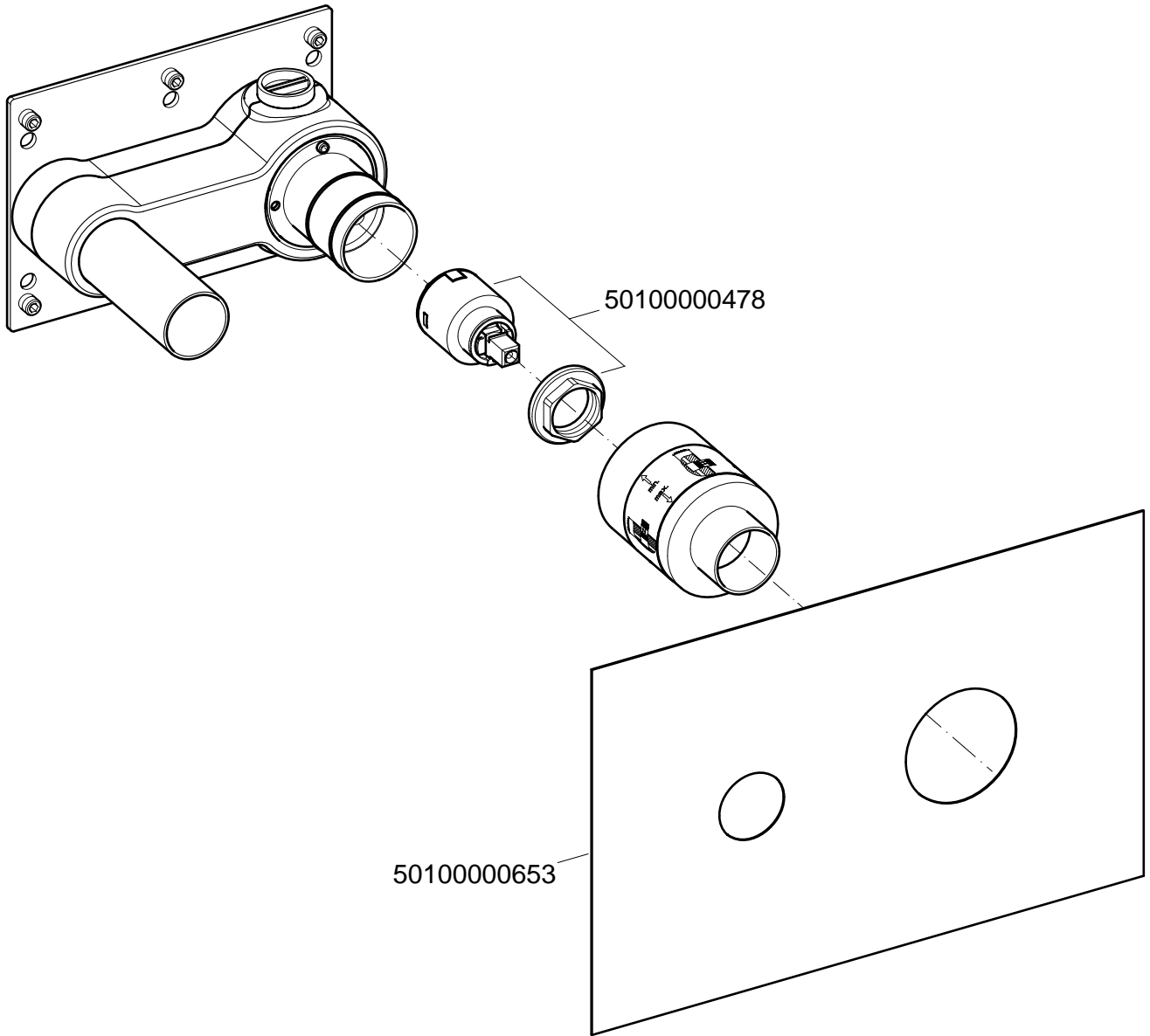

5010000653

5010000478

- 59570000001 (570mm)
- 59570000002 (800mm)
- 59570000003 (1250mm)

