

# MAX019

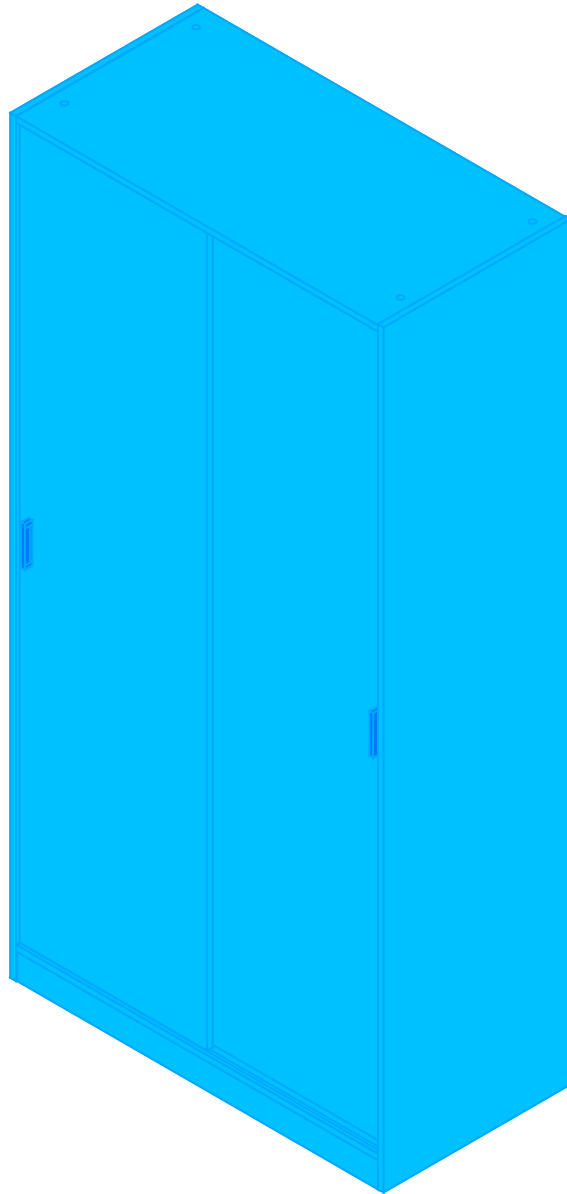







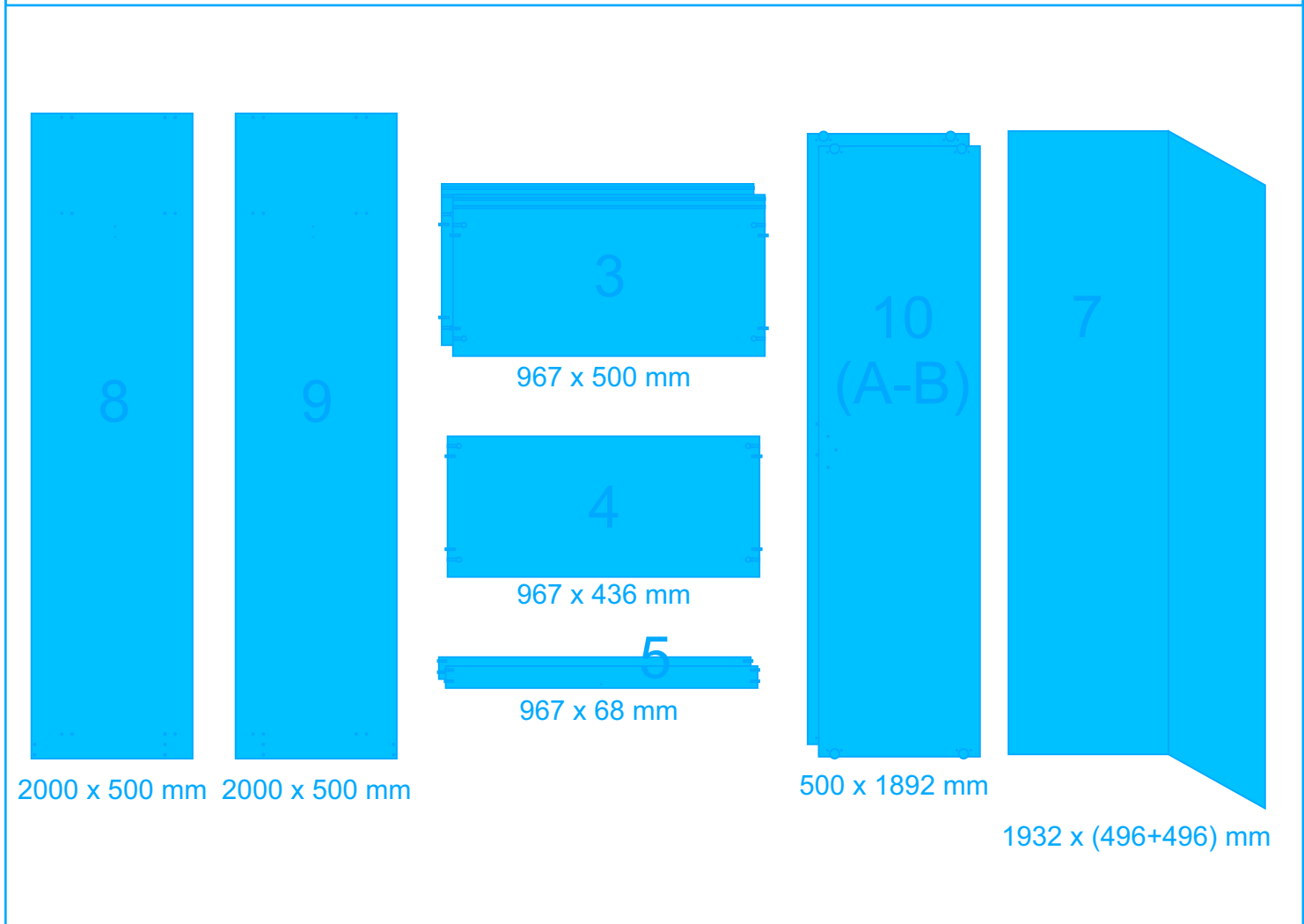
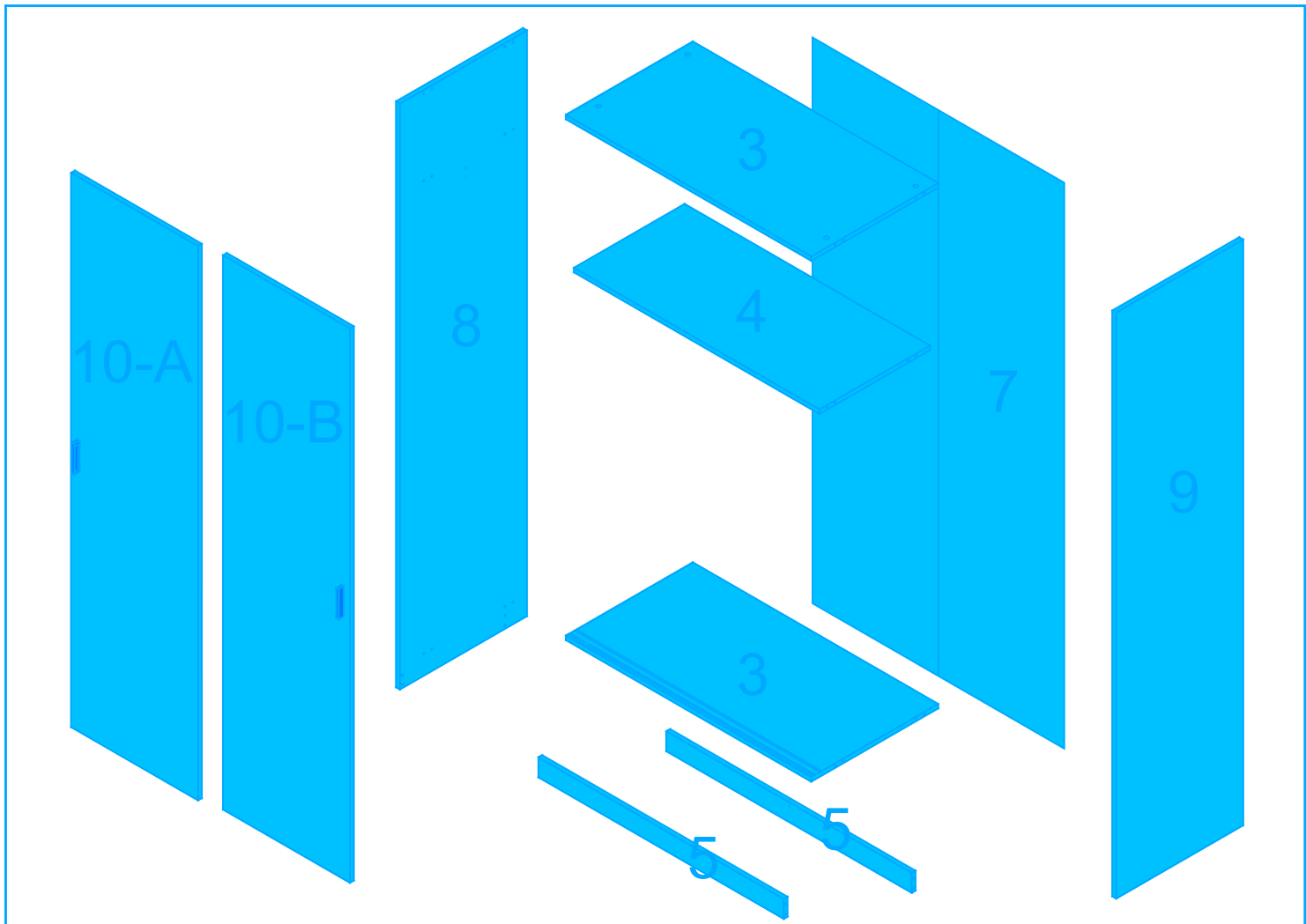

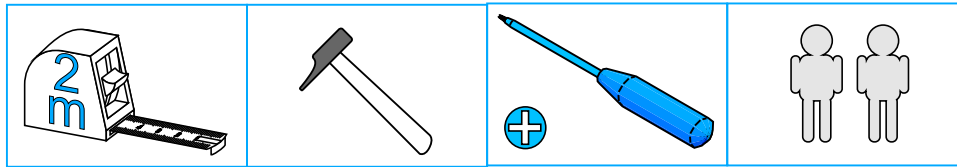

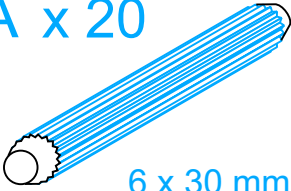
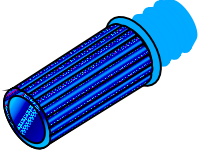
---

**ARMARIO - WARDROBE - ARMOIRE - ROUPEIRO -  
GUARDAROVA - KLEIDERSCHRANK - ORMAR - ΝΤΟΥΛΑΠΑ**

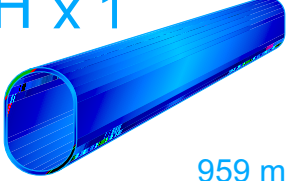
**INSTRUCCIONES DE MONTAJE - ASSEMBLING INSTRUCTIONS - NOTICE DE MONTAGE- INSTRUÇÕES DE MONTAGEM -  
ISTRUZIONI DI MONTAGGIO - MONTAGEANLEITUNG - UPUTE ZA MONTAŽU - ΟΔΗΓΙΕΣ ΣΥΝΑΡΜΟΛΟΓΗΣΗΣ**



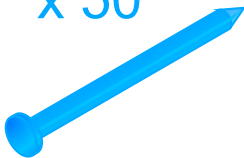

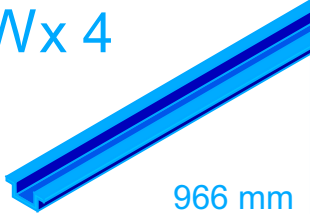
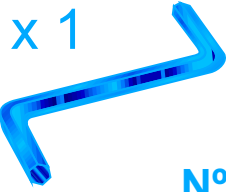
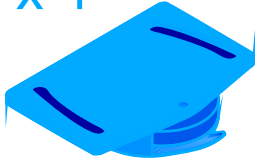
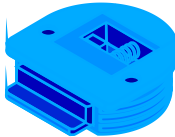
<p>A x 20</p>  <p>6 x 30 mm</p>	<p>B x 1</p> 	<p>E x 12</p> 	<p>F x 12</p> 
<p>G x 2</p> 	<p>H x 1</p>  <p>959 mm</p>	<p>K x 2</p> 	<p>L x 4</p>  <p>15 mm</p>
<p>N x 6</p> 	<p>P x 50</p> 	<p>Q x 2</p> 	<p>W x 4</p>  <p>966 mm</p>
<p>X x 1</p>  <p>N° 4</p>	<p>Y x 4</p> 	<p>Z x 4</p> 	

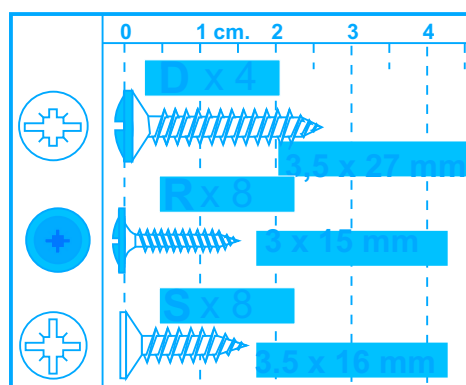

1

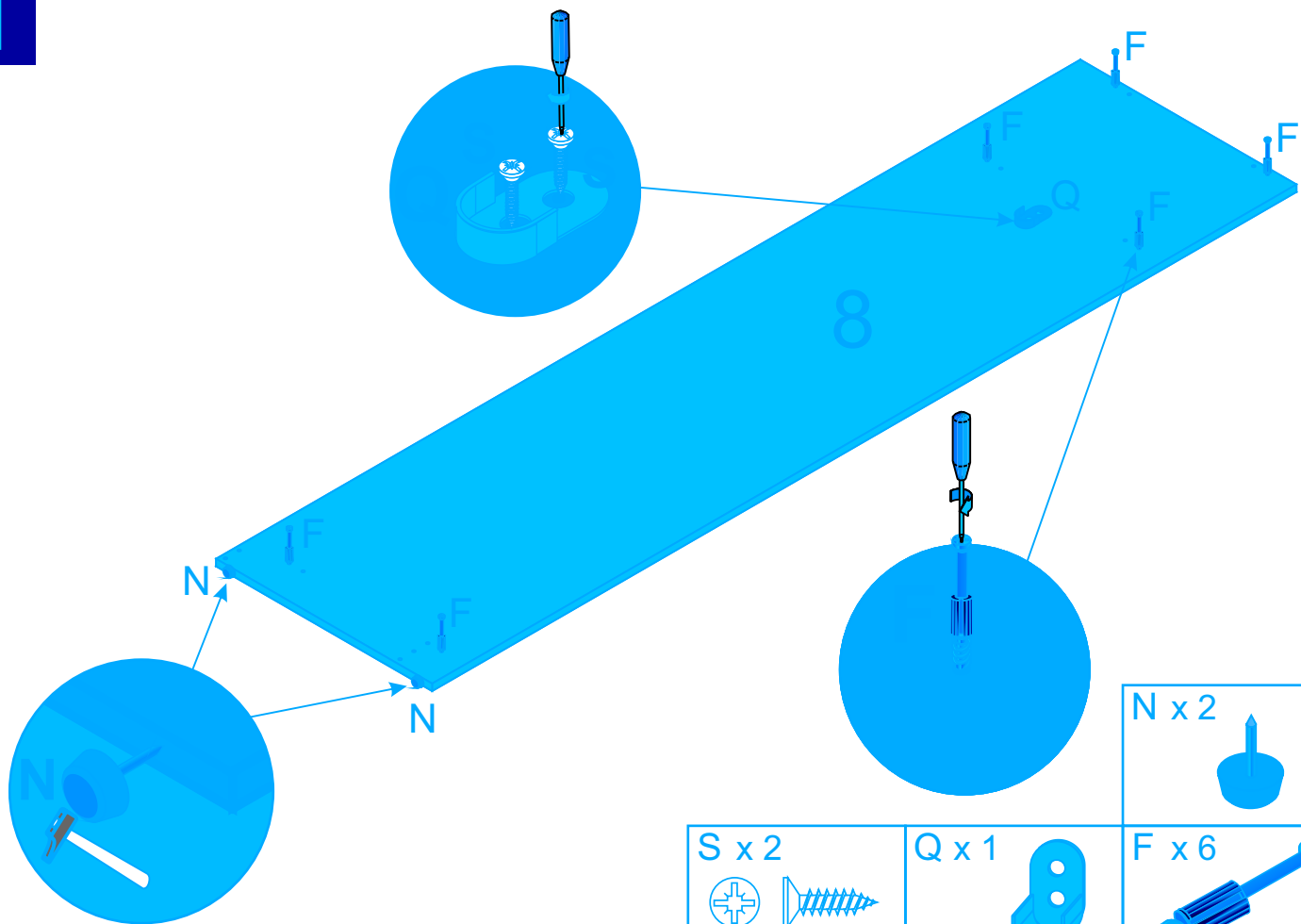

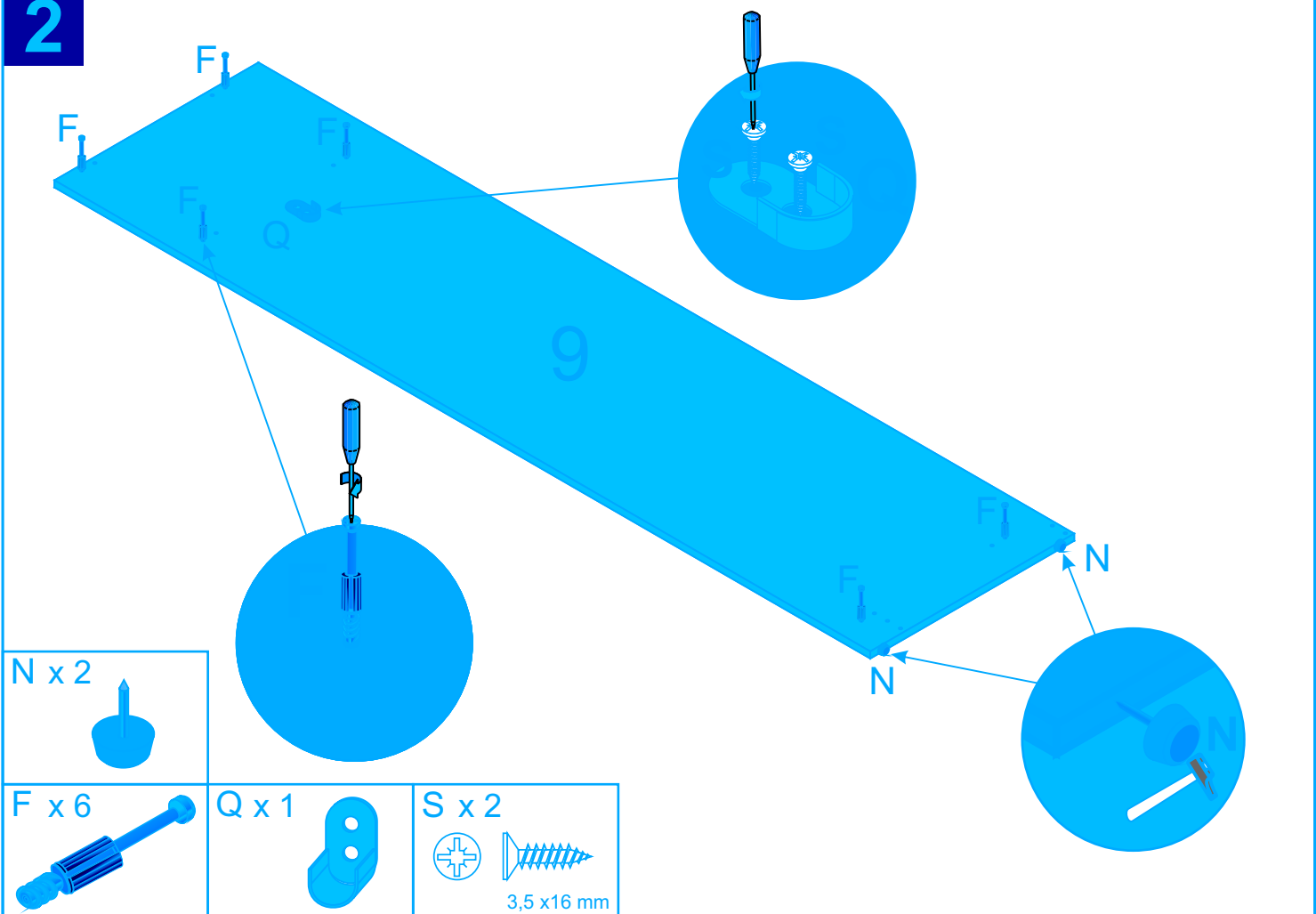

2



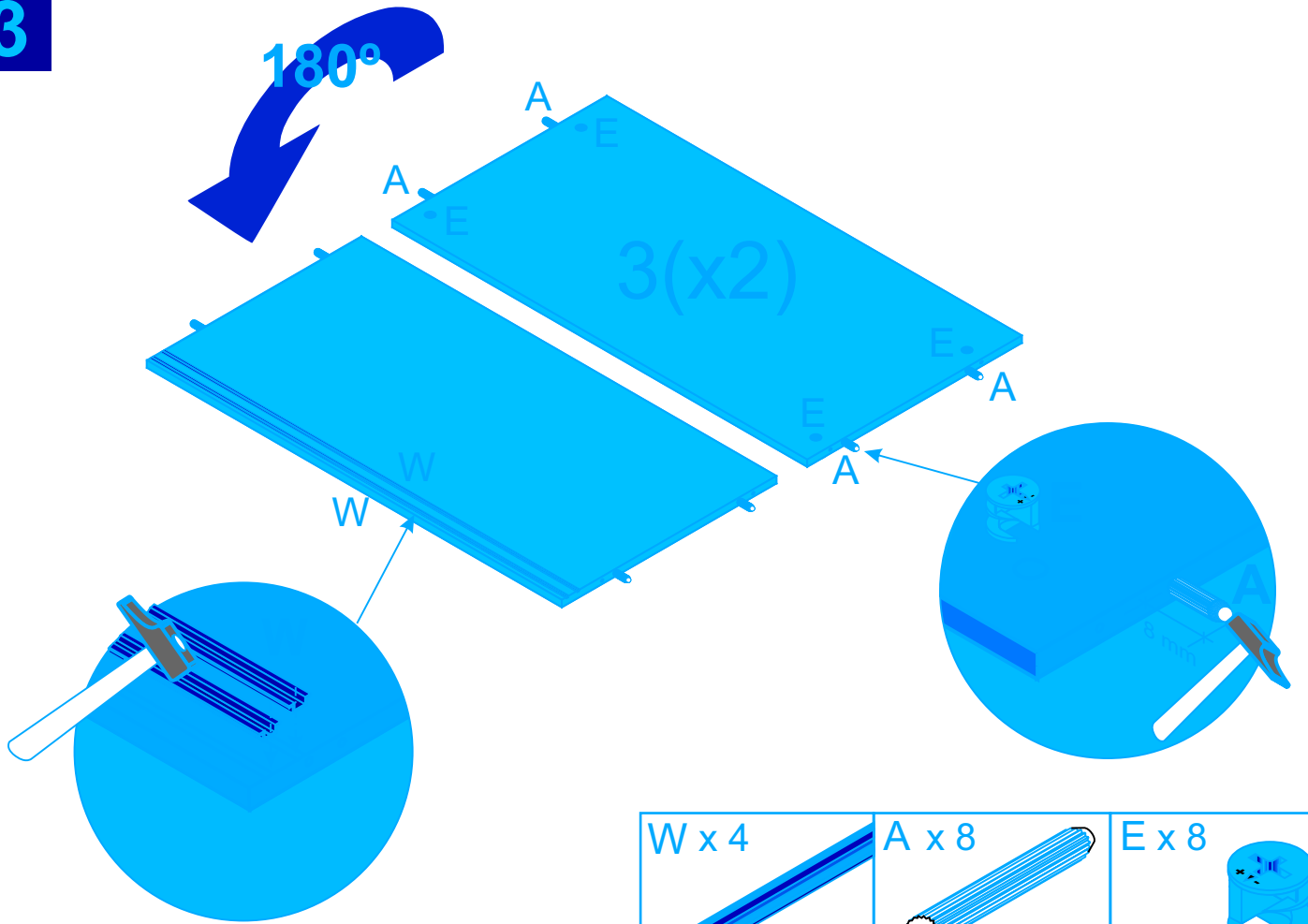

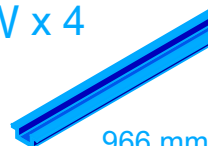
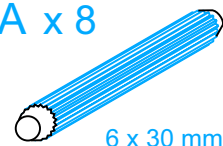
3

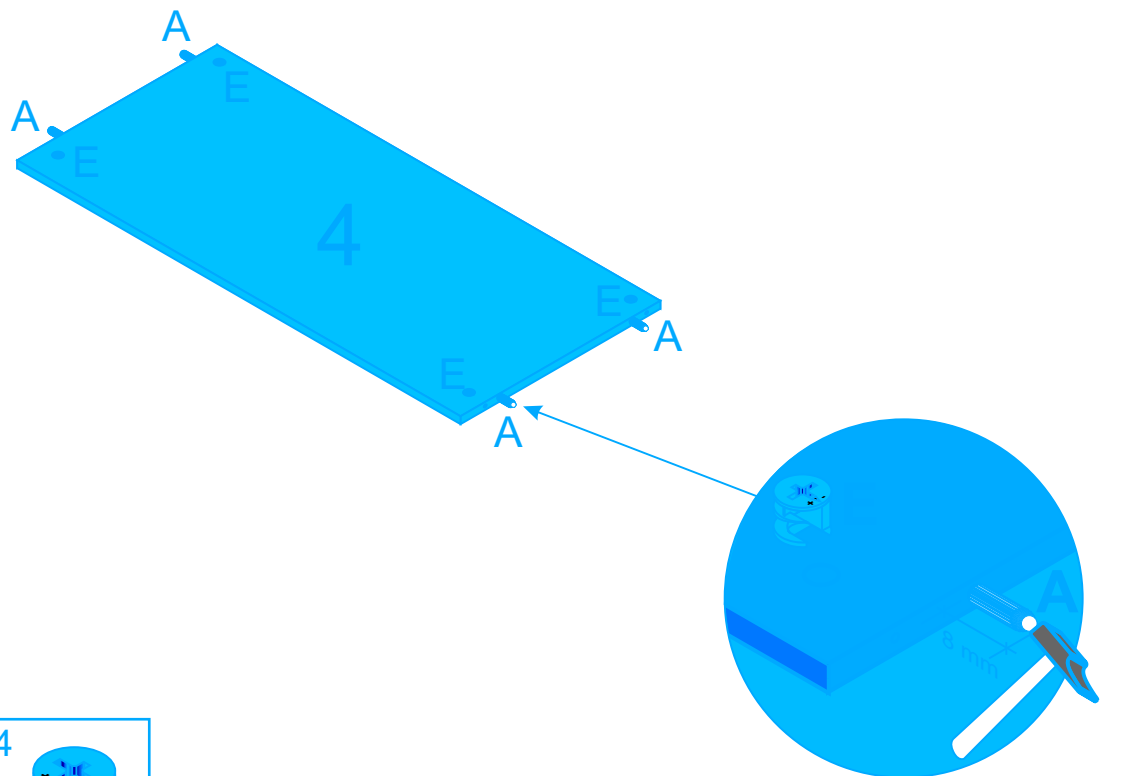

W x 4  966 mm	A x 8  6 x 30 mm	E x 8 
--	--	---

4

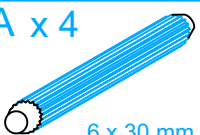

A x 4  6 x 30 mm	E x 4 
--	--

5

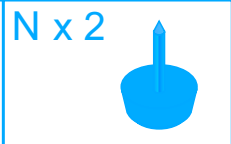
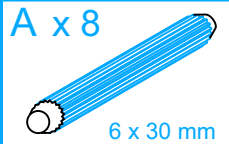
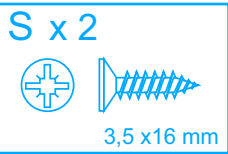
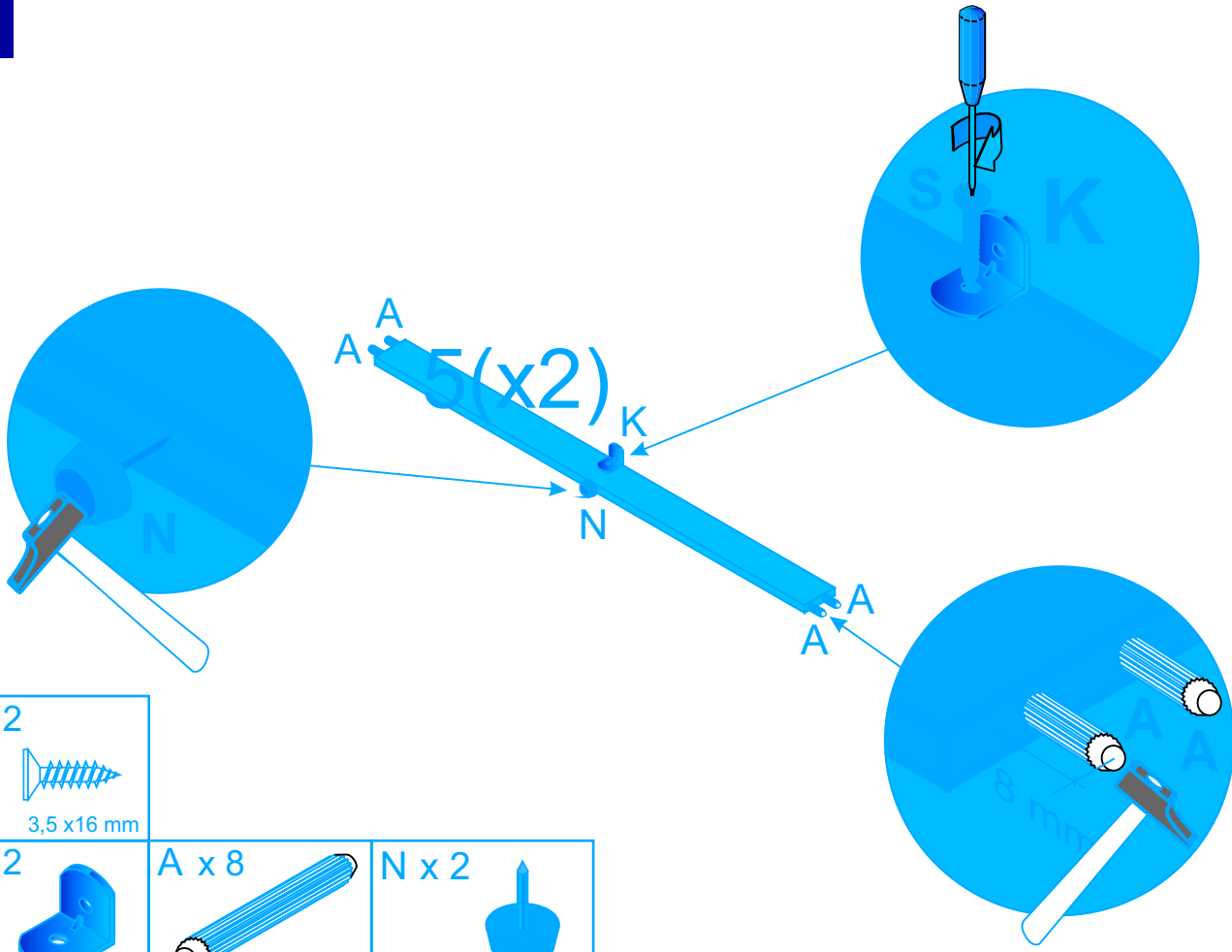

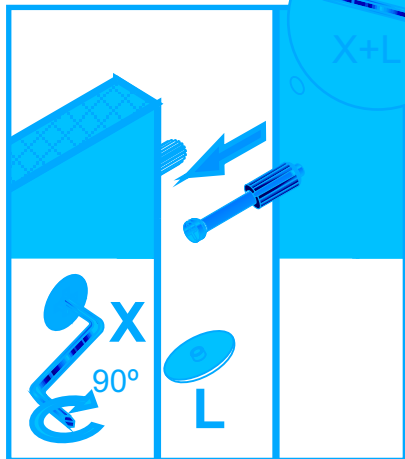
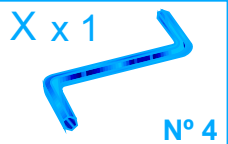
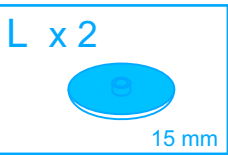
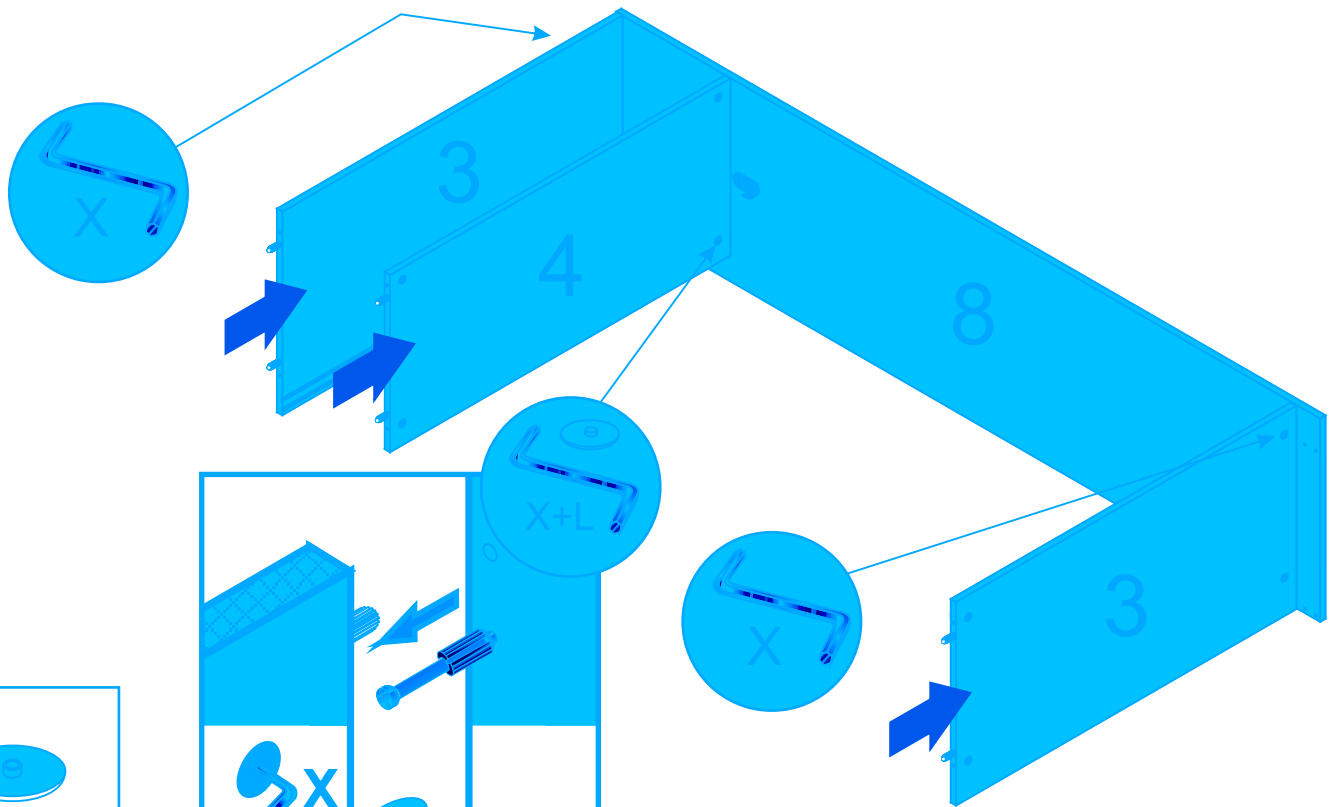

6

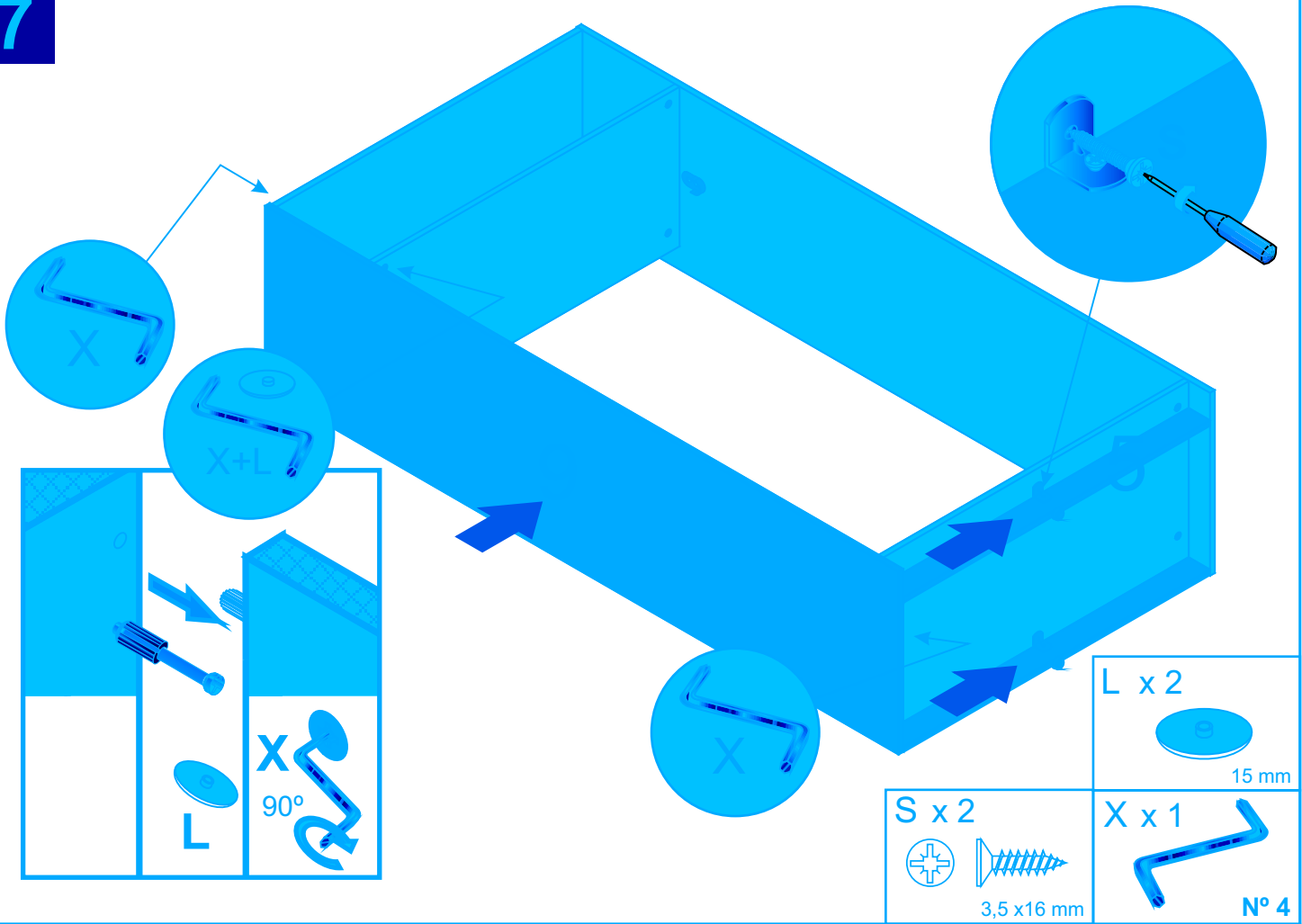

7



L x 2	 15 mm
S x 2	 3,5 x 16 mm
X x 1	 N° 4

8

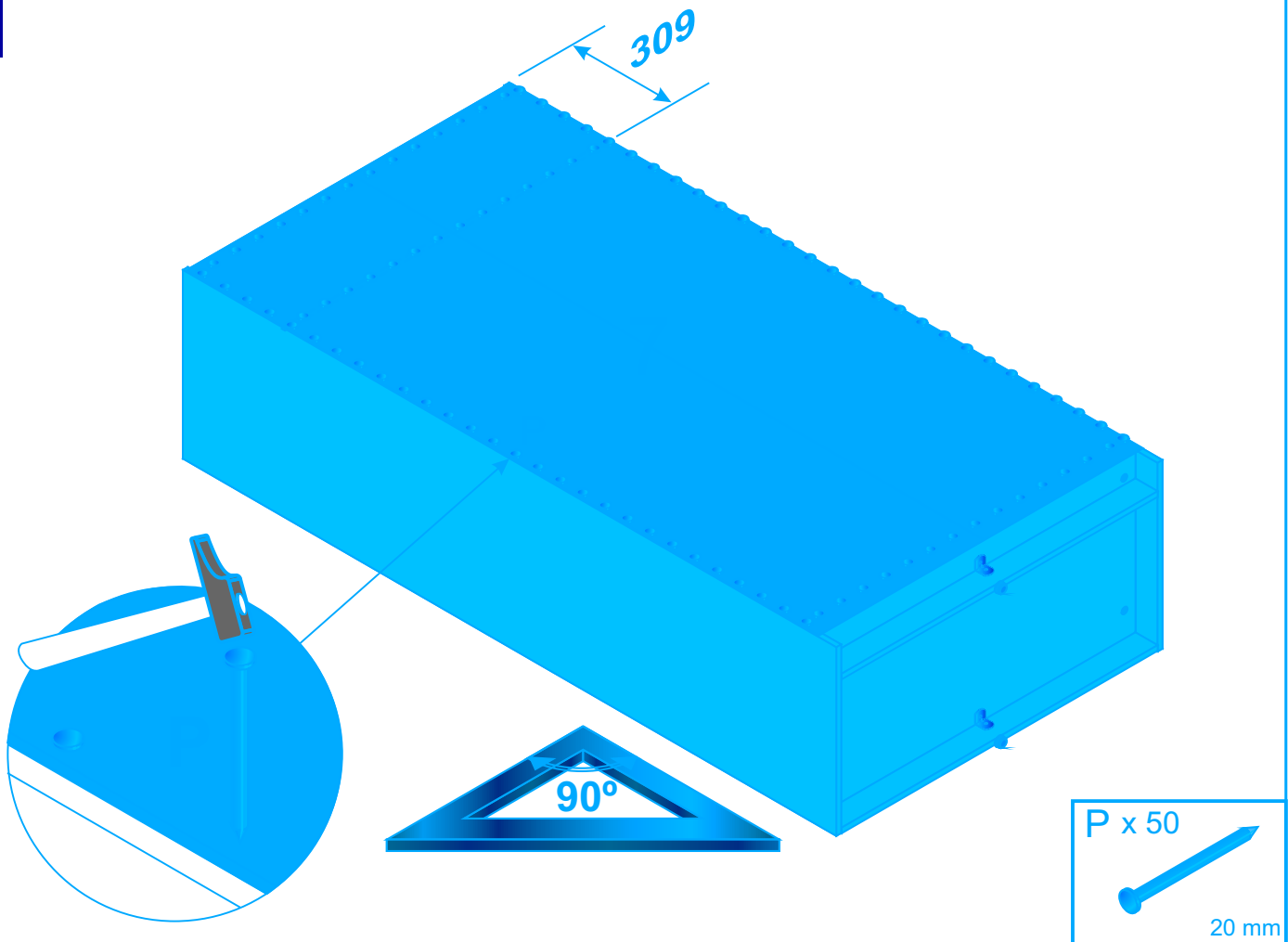

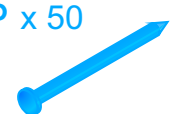
P x 50	 20 mm
--------	--

9

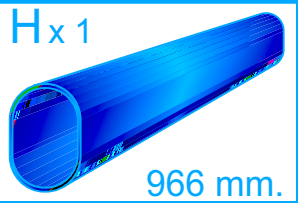
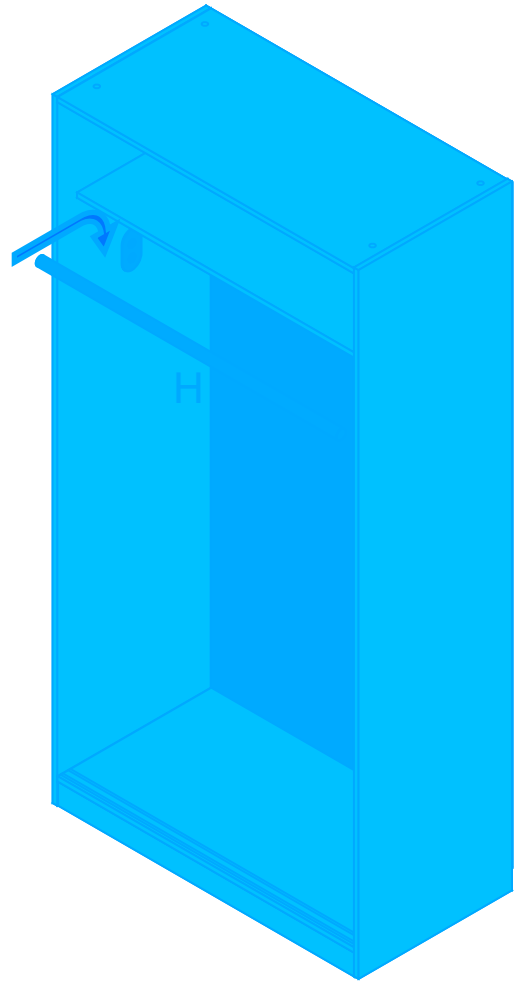
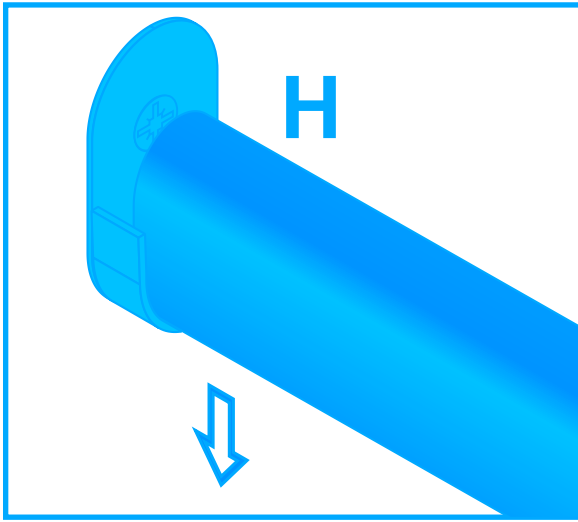

10

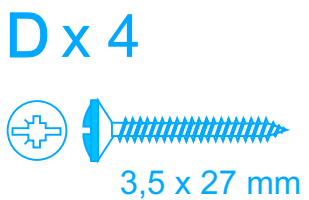
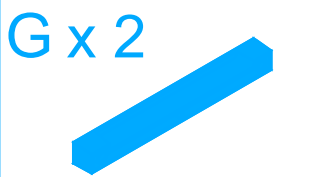
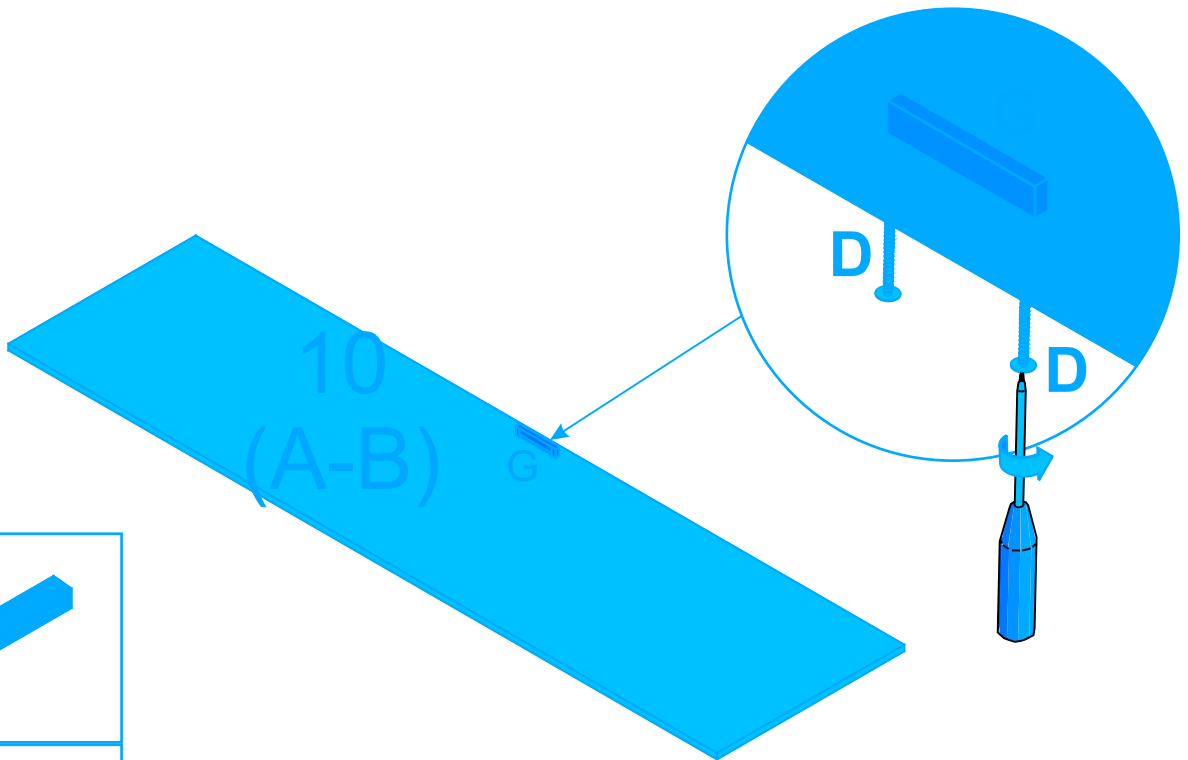

11

x 4



Z x 4

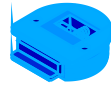

R x 8

3 x 15 mm

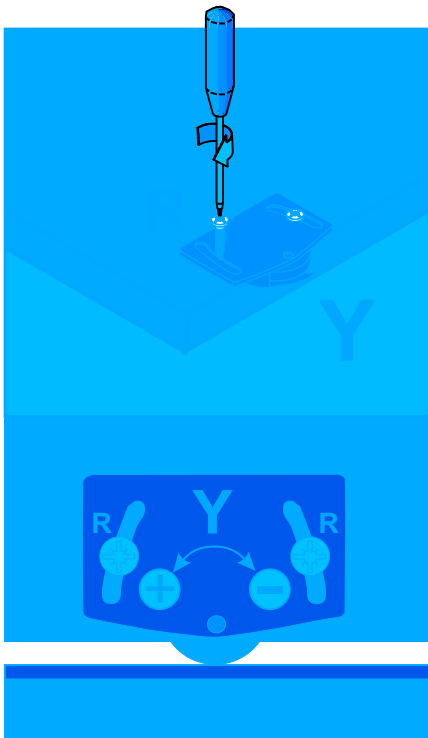
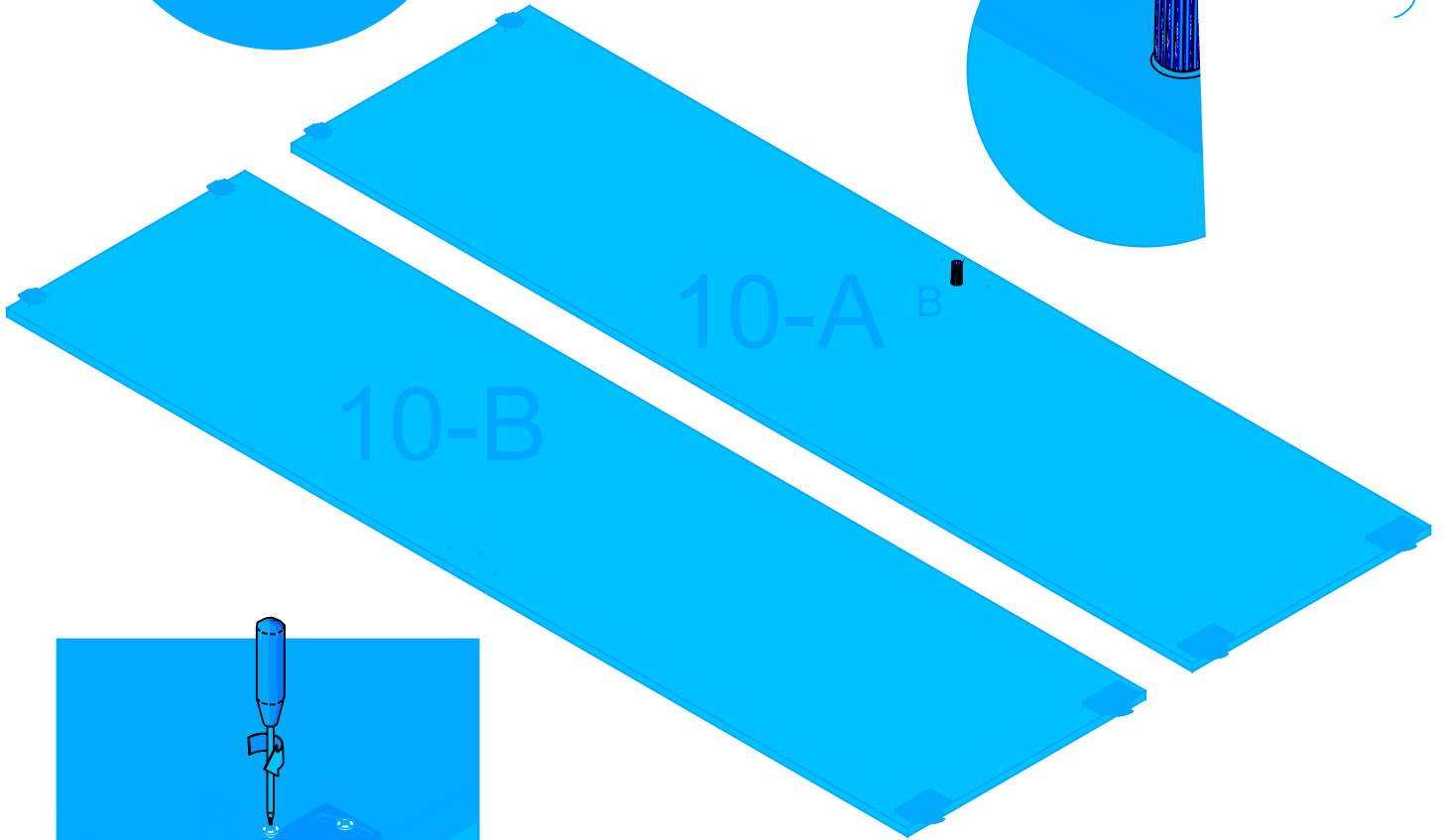
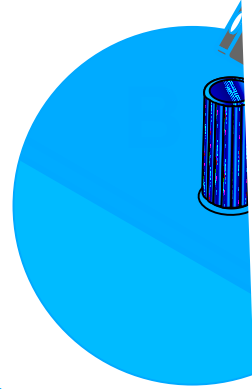
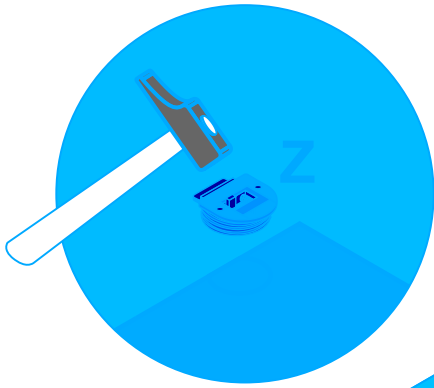

12

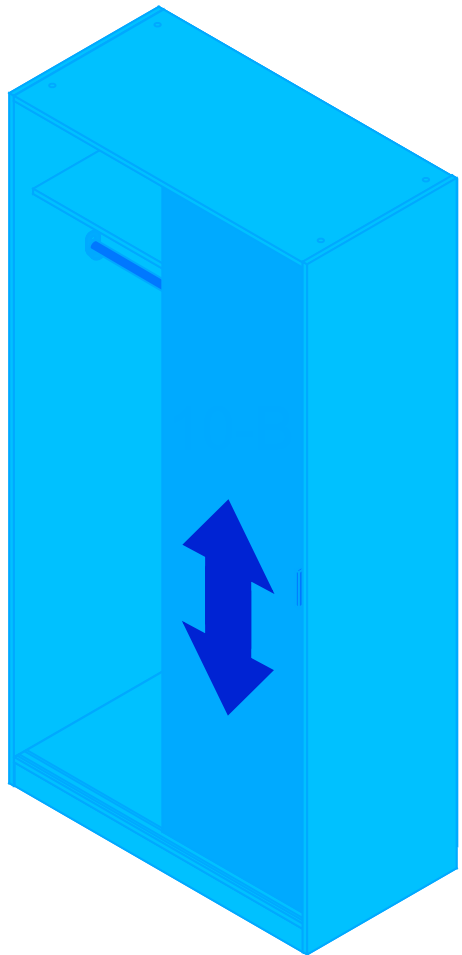
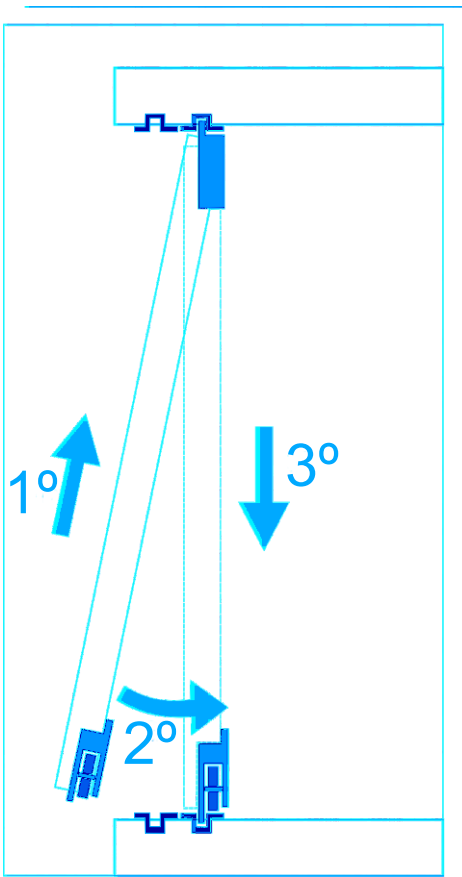

13

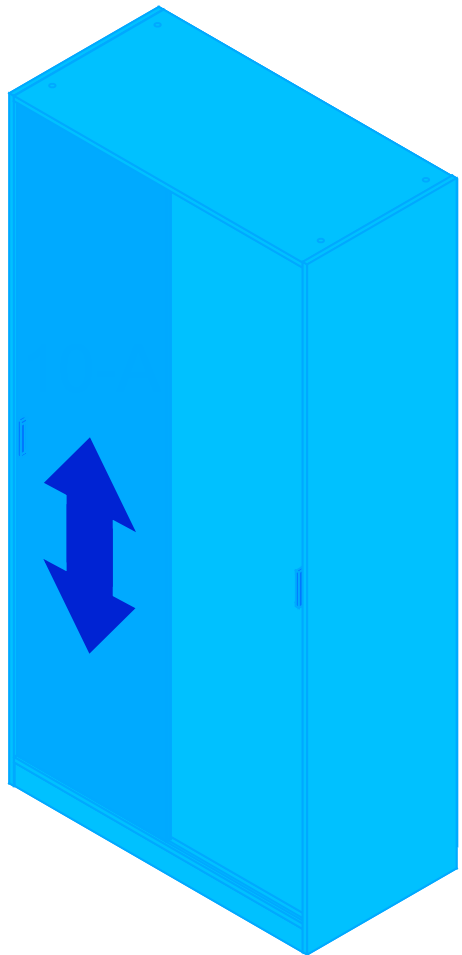
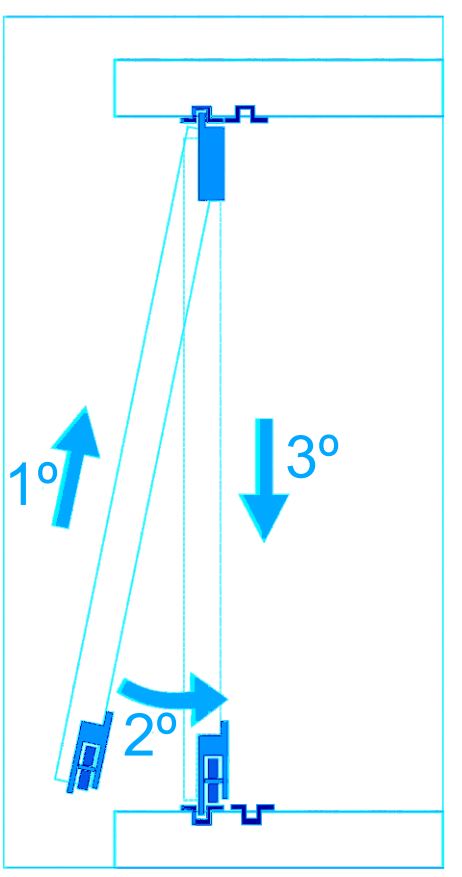

## ES

### RECOMENDACIONES PARA EL MONTAJE Y PARA EL USO

- Preparar las piezas que constituyen el mueble
- Reagrupar y contar el herraje
- Preparar las herramientas necesarias
- Prepara la zona de montaje
- Realizar el montaje sobre una moqueta para evitar rayar el mueble
- No forzar nunca los ensamblajes
- No colocar cerca de fuentes de calor
- No utilizar paños, trapos o productos de limpieza que puedan rayar la superficie del mueble
- Mueble apto para uso doméstico. Ubicación en el interior de la vivienda

## IT

### CONSEGLI PER L'INSTALLAZIONE E L'USO

- Preparate i componenti del mobile per il montaggio
- Ordinate e controllate la quantità della ferramenta
- Preparate gli attrezzi necessari
- Preparate un luogo idoneo al montaggio. Sistemate i componenti su un tappeto per non danneggiare le superfici
- Non forzate mai i componenti
- Non posizionate il mobile vicino a fonti di calore
- Non usate panni abrasivi né detersivi né solventi che possano danneggiare le superfici
- Questo prodotto è solo per uso domestico, non professionale. Non adatto per uso all'aperto

## EN

### RECOMMENDATIONS FOR FITTING AND FOR USE

- Prepare the pieces of furniture to make it up
- Group up and count the iron parts, screws... etc.
- Prepare the necessary tools
- Prepare the fitting place
- Do the fitting on a carpet so you don't damage the furniture
- Never force the fitting
- Do not put near to any sort of heat
- Do not use cloths or cleaning products that could damage the surface of the furniture
- Furniture suitable for domestic use, keep indoors

## DE

### MONTAGEHINWEISE UND GEBRAUCHSHINWEISE

- Sortieren und identifizieren Sie die Einzelteile
- Überprüfen Sie die Anzahl der einzelnen Beschlagteile
- Legen Sie das notwendige Werkzeug bereit
- Einen montagebereich freimachen
- Montieren Sie das Möbel auf einem ebenen, weichen, sauberen Untergrund
- Niemals die verbindungen zu stark anziehen
- Nicht neben Wärmequellen platzieren.
- Für die Reinigung verwenden Sie bitte ein weiches Reinigungsmittel.
- Das Möbel ist ausschließlich für den Gebrauch im Haus geeignet.

## FR

### CONSEILS DE MONTAGE ET POUR L'USAGE

- Identifier les différents panneaux
- Regrouper et compter la quincaillerie
- Munissez-vous de l'outillage nécessaire
- Amenagez-vous une zone de montage. La moquette ou une couverture protégera des rayures
- Ne jamais forcer le montage
- Ne pas placer près des sources de chaleur
- N'utiliser pas de chiffons ou des produits de nettoyage qui puissent rayer la superficie du meuble
- Meuble apte pour l'usage domestique, on peut le placer à l'intérieur de la maison

## HR

### PREPORUKE ZA MONTAŽU I ZA UPORABU

- Pripremite komada namještaja za montiranje
- Pripremite sve dijelove namještaja.
- Pripremite potreban alat
- Pripremite prostor za montažu
- Učinite montažu na tepihu, tako da ne ošteti namještaj
- Nemojte upotrebljavati silu prilikom sklapanja
- Ne stavljajte blizu bilo kakve topline
- Ne koristite krpe ili proizvode za čišćenje koji bi mogli oštetiti površinu namještaja
- Namještaj prikladni za kućnu uporabu.
- Položaj unutar kućišta

## PT

### AVISO PARA MONTAGEM E PARA USO

- Preparar as peças que compõem o móvel
- Reagrupar e contar as ferragens
- Preparar as ferramentas necessárias
- Prepara o local para a montagem
- Efectuar a montagem sobre uma alcatifa para evitar arranhar o móvel
- Não forçar nunca a ensambladura
- Não colocar perto de fontes de calor
- Não utilizar panos, trapos ou produtos de limpeza que possam riscar a superfície do móvel
- Móvel apto para o uso doméstico. Colocação no interior da vivenda

## GR

### ΣΥΜΒΟΥΛΕΣ ΣΥΝΑΡΜΟΛΟΓΗΣΗΣ ΚΑΙ ΧΡΗΣΗΣ

- Προετοιμάστε τα μέρη του επίπλου
- Ομαδοποιήστε και μετρήστε τα μικρά μέρη (βίδες, μεντεσέδες...)
- Προετοιμάστε τα εργαλεία που θα χρειαστείτε
- Προετοιμάστε το χώρο συναρμολόγησης
- Μια moqueta θα προφύλασσει από γρατζουνιές
- Μη ασκείτε πίεση στην εφαρμογή
- Μη τοποθετείτε κοντά σε πηγή θερμότητας
- Μη χρησιμοποιείτε πανιά και καθαριστικά που μπορούν να καταστρέφουν την επιφάνεια
- Το έπιπλο έχει κατασκευαστεί για οικιακή χρήση, τοποθετείστε το στο εσωτερικό της οικίας

## GARANTÍA - GUARANTEE - GARANTIE - GARANTIA - GARANZIA - GARANTIE - JAMČITI - GARANTISI

**ES** · Fabricado en U.E. por FORES DISEÑO S.L. C.I.F: B-12313003 - Ctra.Nac.232; Km 11,1 C.P. 12320 - Sant Jordi (Castellón) SPAIN - el cual garantiza este producto por un periodo de **2 años** a partir de la fecha de compra, contra todo defecto de fabricación.

· Si se encuentra alguna dificultad a la hora del montaje o existe algún defecto en el mueble, puede contactar con nosotros al **964 46 52 22** o por e-mail: **postventa@fores.es** donde gustosamente atenderemos todas sus consultas. HORARIO: de lunes a viernes de 9h a 14h y de 15h a 18h.

· Esta garantía no ampara los defectos producidos por un mal montaje, utilización indebida o mal uso del mueble.

· Es imprescindible conservar el **ticket** de compra y facilitar el **Nº de Control de Calidad** para cualquier consulta o reclamación.

**EN** · Manufactured in Spain by FORES DISEÑO S.L. CIF B-12313003-ctra Nac 232 km 11.1 C.P.12320-Sant Jordi, (Castellón) SPAIN - Guarantee of **2 years** from date of purchase against any fault of production.

· If a difficulty when assembly or a fault in the product is found you can contact us at **(+34) 964 46 52 22** or by email: **postventa@fores.es** where we will be pleased to help you. TIMETABLE: Monday until Friday 9-14h / 15-18h.

· The Guarantee does not cover the faults produced by an incorrect assembly or misuse of the furniture.

· Indispensable to keep the purchase **ticket** and facilitate the **Nº of Quality Control** for any consult or claim.

**FR** · Fabriqué en UE par FORES DISEÑO S.L. CIF B-12313003 - Ctra Nac 232; Km 11,1 CP12320 - Sant Jordi (Castellón) Espagne - Celui ci garantie ce produit pour une période de **2 ans** à partir de la date d'achat, contre tout défaut de fabrication.

· Si vous rencontrez une quelconque difficulté à l'heure du montage ou si il y a un défaut sur le meuble, vous pouvez nous contacter par téléphone au **(+34) 964 46 52 22** ou bien par e-mail à **postventa@fores.es** où nous aurons le plaisir de vous accueillir pour toutes demandes. Nos HORAIRES sont du lundi au vendredi de 9H00 à 14H00 et de 15H00 à 18H00.

· Cette garantie ne couvre pas les défauts résultants d'un mauvais montage, d'une utilisation indue ou d'un mauvais usage du produit.

· Il est indispensable de garder le **ticket** ou facture d'achat et de communiquer le **Numéro de Control Qualité** pour une quelconque demande ou réclamation.

**PT** · Fabricado U.E. por FORES DISEÑO S.L. C.I.F: B-12313003 - Ctra.Nac.232; 11,1 km C.P. 12320 - Sant Jordi (Castellón) ESPANHA - que garante este produto por um período de **2 anos** a partir da data de compra; contra defeitos de fabricação.

· Se você encontrar qualquer dificuldade na montagem ou se houver qualquer defeito no armário, você pode contactar-nos pelos seguintes meios: **(+34) 964 46 52 22** ou por e-mail: **postventa@fores.es** onde será recebido de bom grado para atendermos todas as suas dúvidas. HORÁRIOS: Segunda a sexta-feira das 9h às 14h e 15h às 18h.

· Esta garantia não cobre defeitos causados pela montagem incorreta, uso indevido ou mau trato do produto.

· É essencial manter o **recibo** de compra e facilitar o **Nº Controle de Qualidade** para quaisquer dúvidas ou reclamações.

**IT** · Prodotto in Spagna da: FORES DISEÑO S.L. CIF B-12313003-ctra Nac 232 km 11.1 C.P.12320-Sant Jordi, (Castellón) SPAIN. Garantito **2 Anni** dalla data di acquisto contro ogni difetto di produzione.

· In caso di difficoltà nel montaggio o di mancanza di componenti potete chiamare il **(+34) 964 46 52 22** o inviare email a: **postventa@fores.es**

Il servizio è attivo dal Lunedì al Venerdì ore 9:00-14:00 / 15:00-18:00 Saremo lieti di aiutarvi.

· La garanzia non copre difetti o danni dovuti a montaggio scorretto o ad uso improprio del prodotto.

· La garanzia è valida solo in presenza dello **scontrino di acquisto** e sarà più tempestiva se conservate il **nº di controllo qualità** presente nella confezione.

**DE** · Hergestellt in Spanien von FORES DISEÑO S.L. CIF B-12313003-ctra Nac 232 km 11.1 CP12320-Sant Jordi (Castellón) SPANIEN - Garantie von **2 Jahren** ab Kaufdatum gegen jede störung der produktion.

· Wenn Sie irgendwelche schwierigkeiten bei der montage zu finden oder es irgendeinen defekt in dem schrank, können sie uns unter **(+34) 964 46 52 22** oder per email an: **postventa@fores.es**, wo wir gerne besuchen, um alle Ihre Fragen. ÖFFNUNGSZEITEN: Montag bis Freitag von 9h bis 14h und 15h bis 18h.

· Diese Garantie gilt nicht für Mängel, die durch unsachgemäße Installation, unsachgemäße Behandlung und Verwendung des Geräts verursacht werden.

· Unentbehrlich, um den **Kauf Ticket** behalten und erleichtern die Anzahl der **Qualitätskontrollzahl** für alle zu konsultieren oder Anspruch.

**HR** · Proizvedeno u Španjolskoj od strane FORES DISEÑO S.L. cif B-12313003-CTRA Nac 232 km 11,1 CP12320-Sant Jordi, (Castellón) Španjolska - jamstvo **2 godine** od datuma kupnje protiv krivnjom proizvodnje.

· Ako poteškoća kada se utvrdi Skupština ili greška u proizvodnju možete nas kontaktirati na **(+34) 964 46 52 22** ili putem e-maila: **postventa@fores.es** gdje ćemo biti drago da vam pomogne. RASPORED: ponedjeljak do petka 9-14h / 15-18h.

· Jamstvo ne pokriva kvarove produkciji pogrešne montaže ili zlouporabe namještaja

· Neophodan zadržati kupnju **ulaznica** i olakšati **Nº kontrole kvalitete** za bilo konzultirati ili zahtjev.

**GR** · Κατασκευάζεται στην Ισπανία από CIF B-12313003-Ctra Nac 232 χλμ 11.1 CP12320-Sant Jordi, στην Ισπανία - Η εγγύηση ισχύει για **2 έτη** από την αρχική ημερομηνία αγοράς και καλύπτει ελαττωματικά υλικά ή ελαττωματική κατασκευή του προϊόντος.

· Σε περίπτωση δυσκολίας σας κατά την συναρμολόγηση ή πιθανής βλάβης στο προϊόν, μπορείτε να επικοινωνήσετε μαζί μας στο **(+34) 964 46 52 22** ή μέσω email:

**postventa@fores.es** Θα χαρούμε να σας βοηθήσουμε. ΗΜΕΡΕΣ & ΩΡΕΣ ΕΞΥΠΗΡΕΤΗΣΗΣ: Δευτέρα έως Παρασκευή 9:00-14:00 & 15:00-18:00.

· Η εγγύηση δεν καλύπτει τις βλάβες που προέρχονται από λάθη στην συναρμολόγηση ή την μη ορθολογική χρήση των επίπλων.

· Είναι απαραίτητο να κρατήσετε την **απόδειξη αγοράς** του προϊόντος και τον **αριθμό ποιοτικού ελέγχου**, ώστε να διευκολύνετε οποιαδήποτε διαδικασία αίτησης ή συμβουλής χρειαστείτε.

**Nº de Control de Calidad:**

**Nº of Quality Control:**

**Nº de Contrôle Qualité:**

**Nº de Controle de Qualidade:**

**Nº di Controllo qualità:**

**Qualitätskontrollzahl:**

**Nº kontrole kvalitete:**

**Nº kalite kontrol:**

00000.17



---

**ARMARIO - WARDROBE - ARMOIRE - ROUPEIRO -  
GUARDAROVA - KLEIDERSCHRANK - ORMAR - ΝΤΟΥΛΑΠΑ**

