

Einbauanleitung

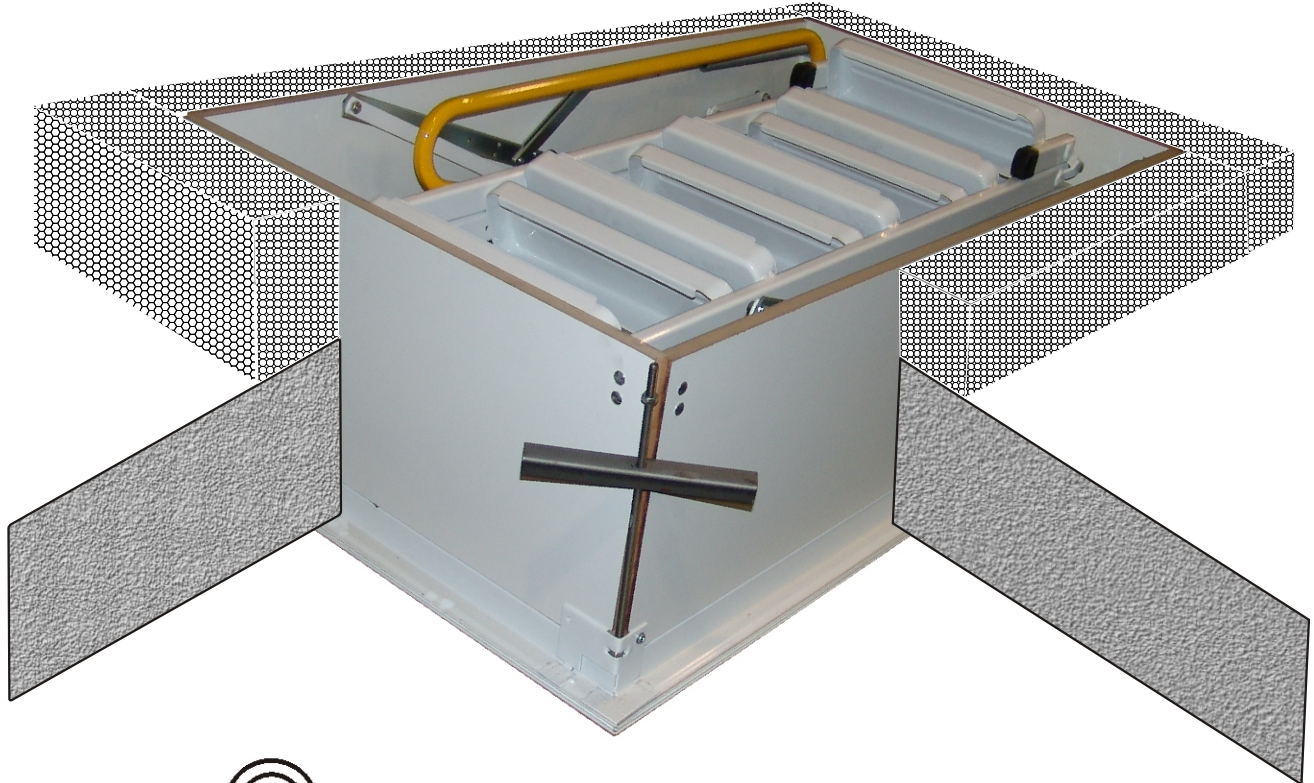

H (1x)

Schnapperring
63x25xD 4 mm



A (8x)

Sechskantmutter
M 8 DIN 934

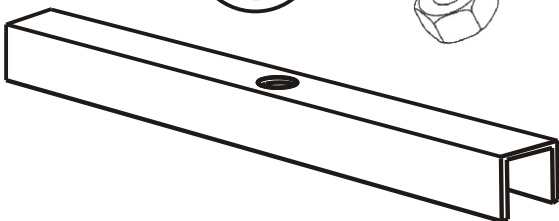

D (4x)

Überlager U-Profil
20x20x2x300

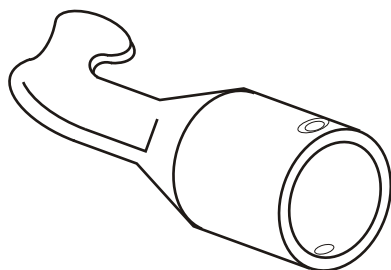

M (1x)

Zugstockhaken
30 x 87 mm



H (2x)

Spanplattenschraube
3 x 16 mm

1

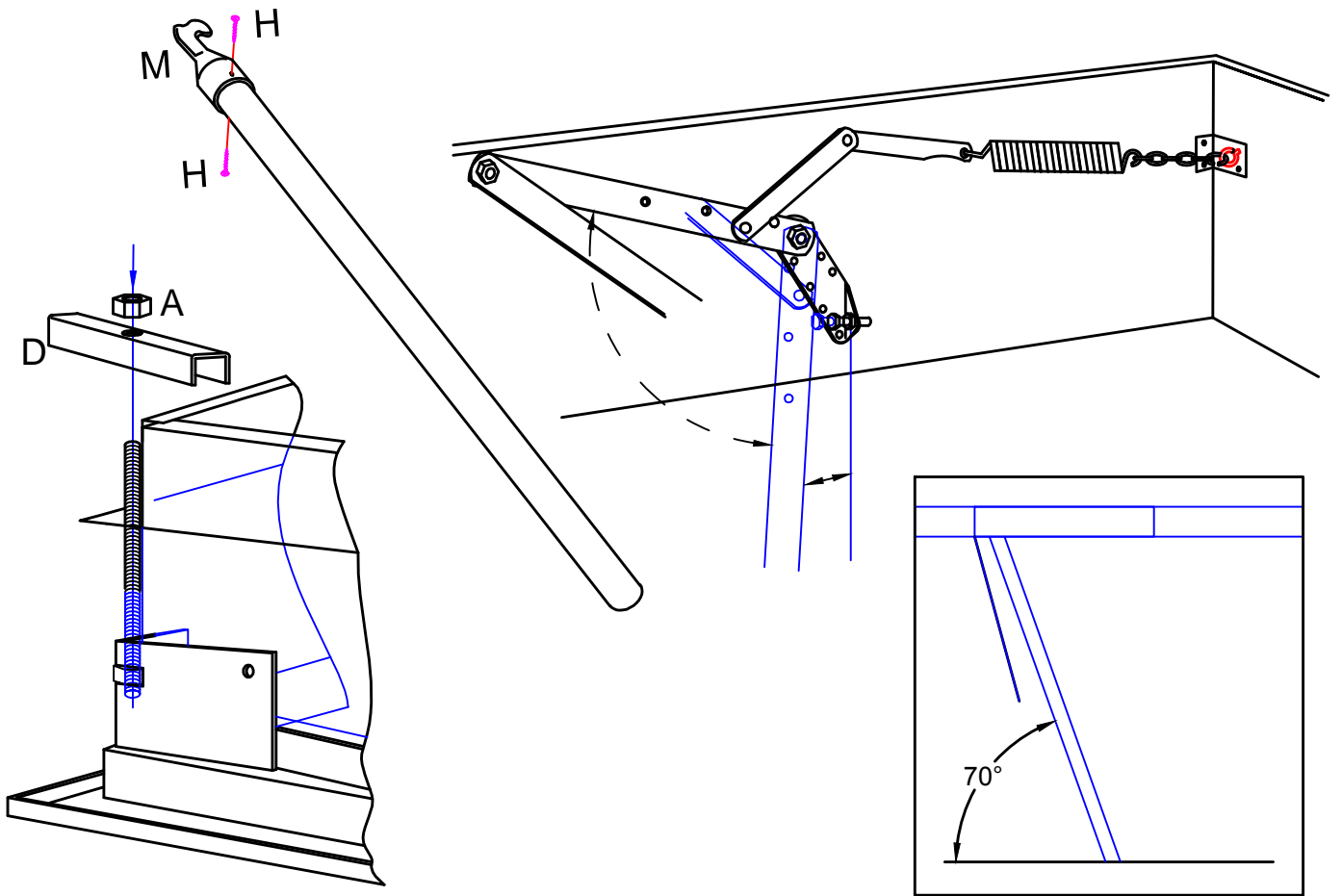

2

