

## DE Aufbauanleitung „HighBoard 160“

- Ⓞ GB Assembly manual for „HighBoard 160“
- Ⓞ FR Notice de montage du „HighBoard 160“
- Ⓞ NL Opbouwbeschrijving voor „HighBoard 160“
- Ⓞ ES Instrucciones de montaje de “HighBoard 160”
- Ⓞ IT Istruzioni di montaggio “HighBoard 160”



# Wichtige Punkte für den Aufbau!

(GB) Important details regarding assembly! (FR) Points importants lors du montage! (NL) Belangrijke punten voor de montage!  
(ES) ¡Notas importantes para el montaje! (IT) Indicazioni importanti per il montaggio!



## Um Kratzer zu vermeiden, verwenden Sie bitte geeignete Unterlagen!

- (GB) Please use a suitable underlay to avoid scratches!  
(FR) Pour éviter les rayures, utilisez les supports appropriés!  
(NL) Om krassen te voorkomen raden wij u aan er iets onder te leggen!  
(ES) Por favor, coloque en el suelo una base protectora adecuada para evitar posibles arañazos.  
(IT) Utilizzare una base adatta per evitare graffi!



## Schraubenverbindungen grundsätzlich erst am Ende der Montage festziehen!

- (GB) Nuts not to be tightened before the end of assembly!  
(FR) Ne serrer les écrous à fond qu'à la fin du montage!  
(NL) Schroeven pas aan het einde van de montage vastdraaien!  
(ES) En principio, no apriete fijamente las tuercas hasta que no haya terminado de montar la caseta.  
(IT) I dadi devono essere serrati a fondo soltanto alla fine del montaggio!

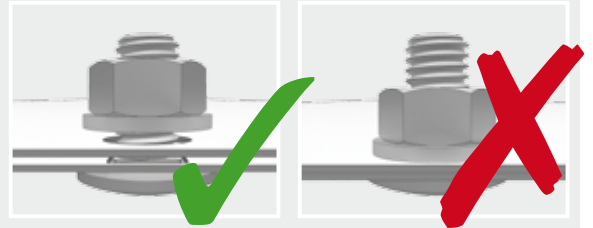

## Nicht bei Wind aufbauen!

- (GB) Do not assemble the box on a windy day!  
(FR) Ne pas assembler quand il y a du vent !  
(NL) Niet opbouwen in de wind!  
(ES) ¡No montar con ráfagas de viento!  
(IT) Non costruire nel vento!



## Verwenden Sie bei der Montage Arbeitshandschuhe!

- (GB) Wear working gloves!  
(FR) Portez des gants de travail  
(NL) Handschoenen gebruiken!  
(ES) Utilice unos guantes de trabajo.  
(IT) Utilizzare guanti da lavoro



## Maßstabsgetreue Abbildungen der zu verwendenden Schrauben:

- (GB) Scale drawing 1:1 of the screws in use  
(FR) Reproduction selon l'échelle 1:1.  
(NL) Afbeelding : schaal 1:1 (ware grootte)  
(ES) Reproducción a escala 1:1 de los tornillos que se utilizan para el montaje.  
(IT) Immagine in scala delle viti da utilizzare!

M 1:1

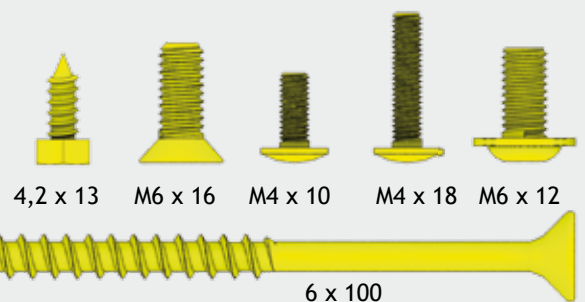

## Optionales Zubehör - Symbol:

Arbeitsschritte die blau eingerahmt sind, zeigen den Einbau eines optionalen Zubehörteiles.

- (GB) Symbol of optional accessories: Blue framed assembly steps show the installation of optional accessories.  
(FR) Accessoires en option-synbol: La trame entourée en bleu indique une étape avec accessoires en option. A réaliser uniquement si vous avez commandé cet accessoire.  
(NL) Extra Toebehoor: Montagestappen met een blauwe rand betreffen de inbouw van extra toebehoor.  
(ES) Accesorio opcional - símbolo: Los pasos de montaje que se encuentran enmarcados en azul muestran el montaje de una pieza de un accesorio opcional.  
(IT) Simbolo per accessori opzionali: Le fasi del montaggio incorniciate in colore azzurro mostrano l'installazione di un accessorio opzionale.



optionales Zubehör - Accesso...

**Werkzeughalter**  
Tool holders - Supports de

# Pflege und Wartung

## (GB) Care and maintenance

## (FR) Entretien et maintenance

- Keine aggressiven Chemikalien wie z.B. Chlor oder Streusalz lagern!
- Sonnenmilch und andere Cremes mit Wasser und Seife entfernen
- Keine scheuernden Reinigungsmittel verwenden!
- Ölen Sie das Schloss jährlich!

- Do not store aggressive substances i.e. chlorine or road salt
- Remove suntan lotion or any other creams with water and rinse aid!
- Do not use abrasive cleaning agents!
- Lubricate the lock once a year!

- Ne pas stocker de produits chimiques (chlore, sel, etc...)
- Nettoyez les traces de crème solaire ou autre uniquement avec de l'eau et du savon!
- Ne pas utiliser de produits nettoyant abrasifs!
- Graissez la serrure et les charnières chaque année !

## (NL) Onderhoud

- Geen chemicaliën in de LoungeBox!
- Zonnebrandolie/melk en andere cremes met water en zeep verwijderen
- Gebruik geen schuurmiddelen!
- Slot jaarlijks oliën

## (ES) Cuidado y mantenimiento

- No almacene productos químicos agresivos dentro del HighBoard, como por ejemplo cloro y sal antiescarba.
- Evite dejar huellas o restos de cremas solares sobre la chapa. Limpie al arcón siempre con agua o un trapo húmedo.
- No utilice ningún producto para fregar. En general, evite siempre cualquier producto químico para limpiar al arcón.
- Aplique aceite en la cerradura y las bisagras una vez al año

## (IT) Manutenzione

- Non lasciare prodotti chimici aggressivi (come ad esempio cloro o sale per strade) all'interno della Loungebox!
- Rimuovere crema solare e altre creme con acqua e brillantante!
- Non utilizzare detergenti contenenti sostanze aggressive!
- Lubrificare la serratura e le cerniere a cadenza annuale!



## Paket Nr. 1



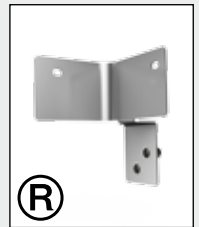
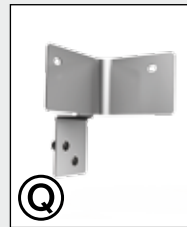
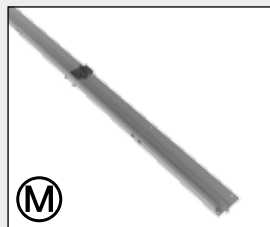
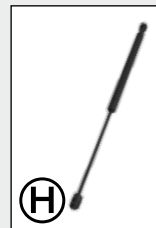
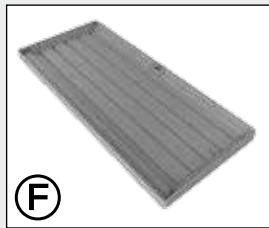
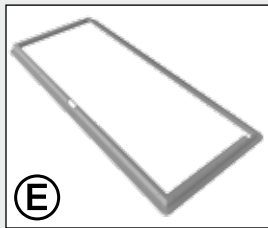
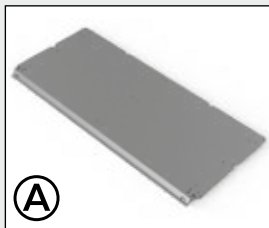

Deckelpaket · lid package · colis du couvercle · dekselpakket · pacchetto di coperchio · pacchetto di coperchio

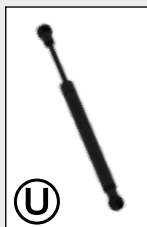
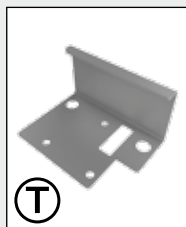
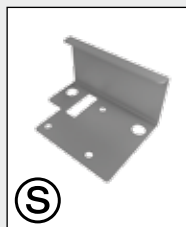
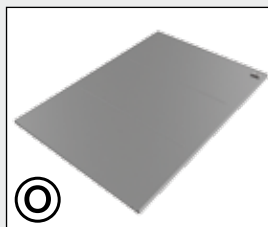
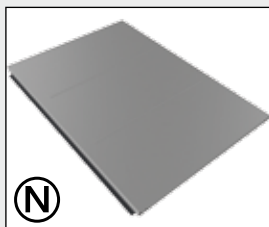
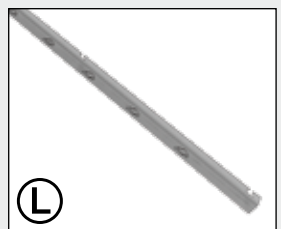
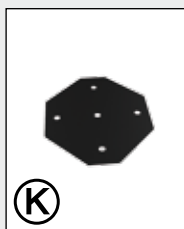
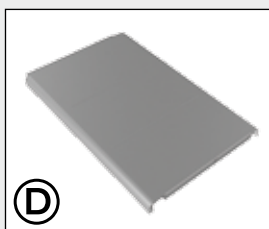
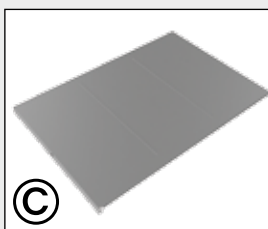
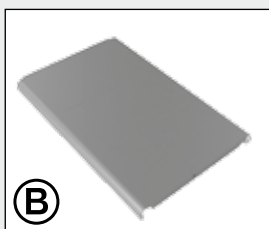

## Paket Nr. 2

Korpuspaket · corpus package · colis de l'ossature · framepakket · corpus · corpus



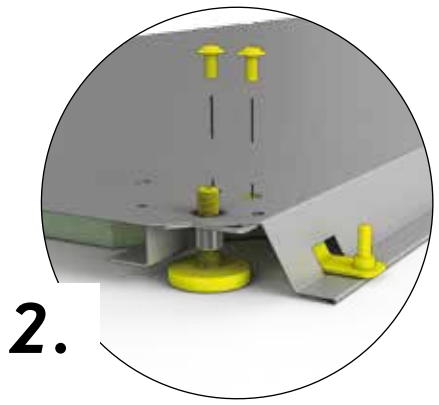
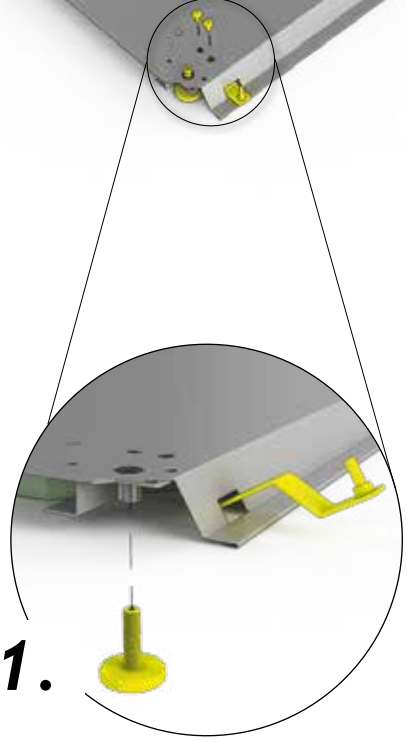
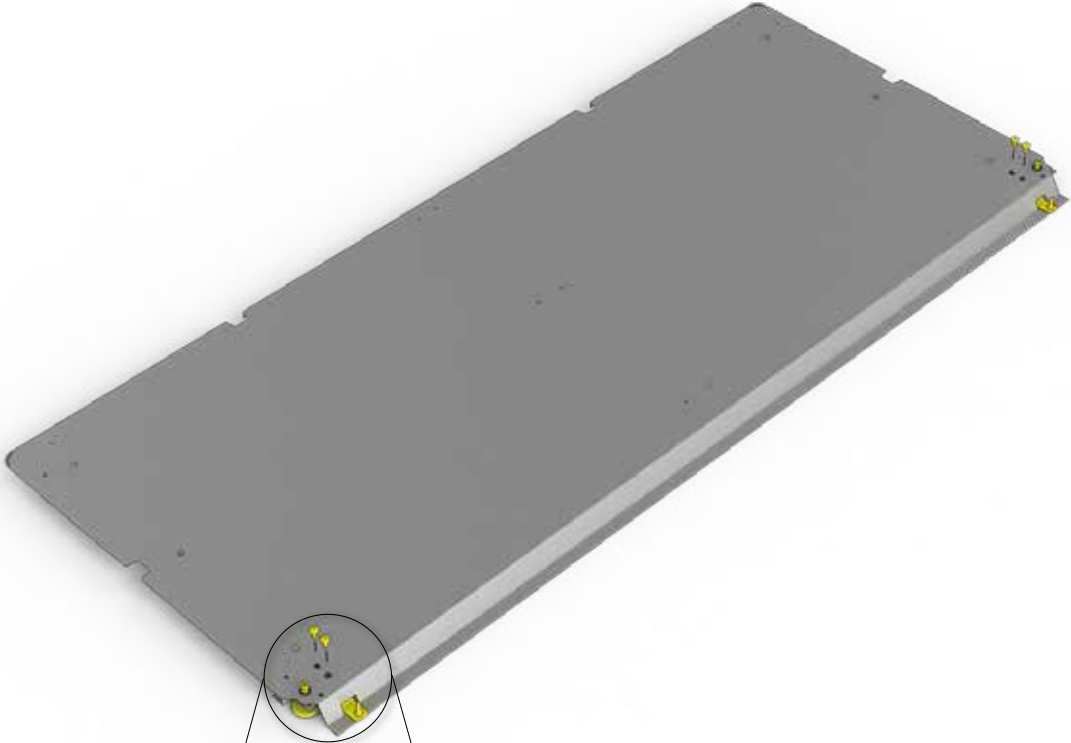

<b>1.</b>  ① ①	1x	 ② ②	2x	 ② ②	2x
	M6 x 12  ② ②		4x		

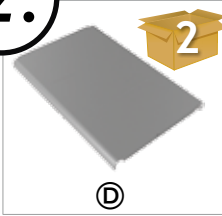

2.

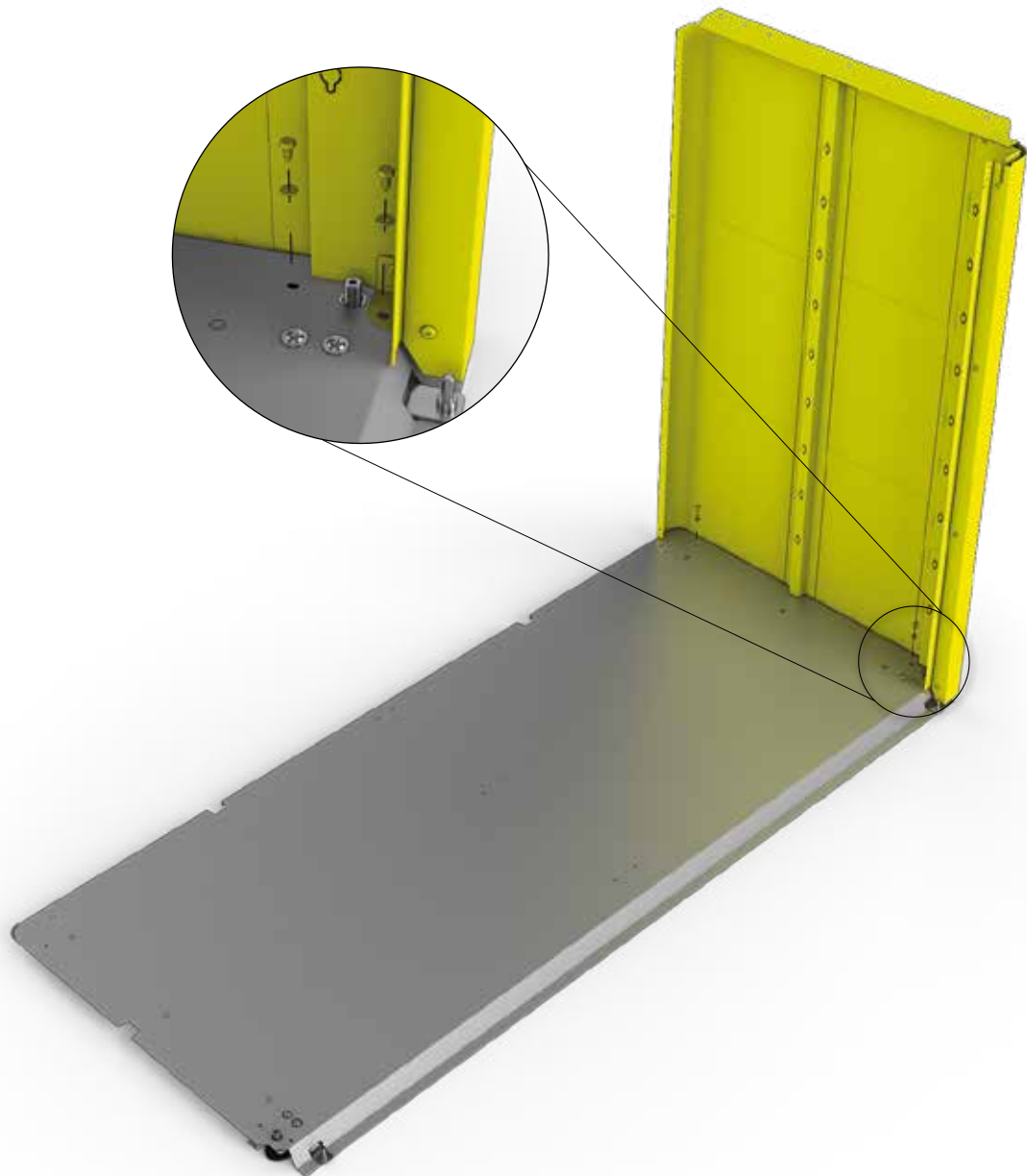

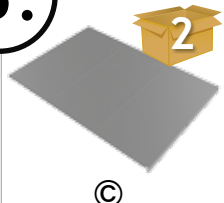
	1x	4,2 x 13 	3x
---	----	--	----

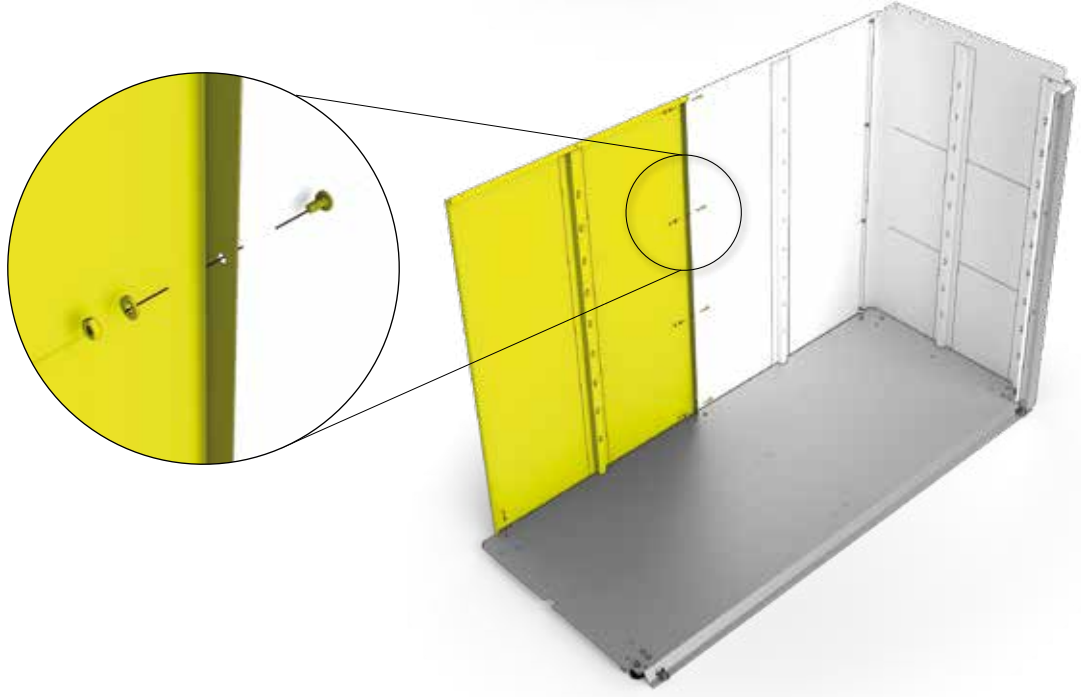
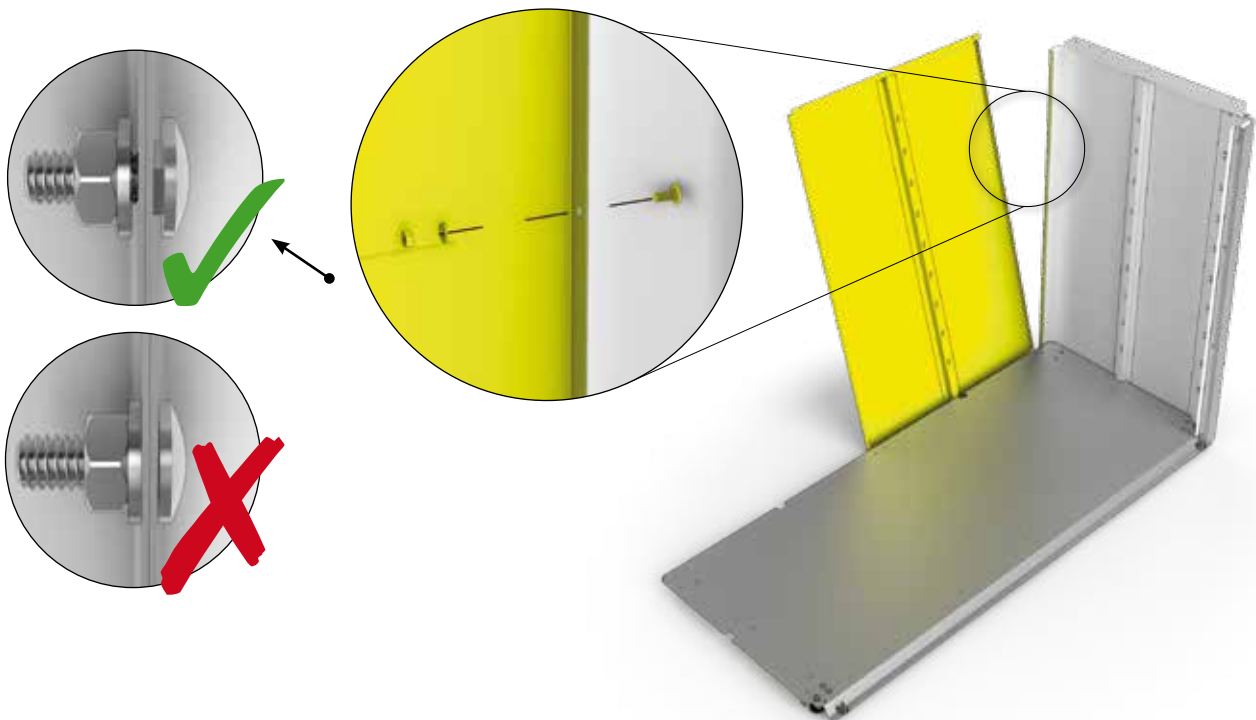
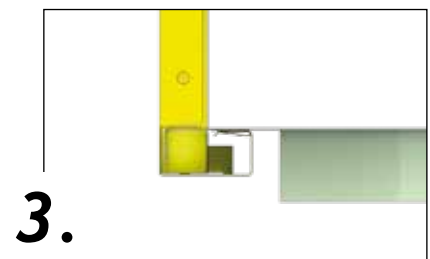
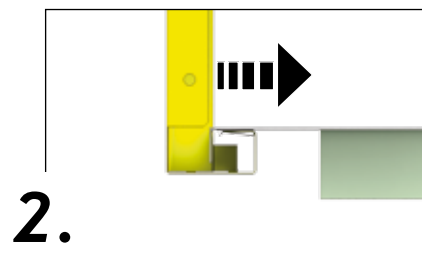
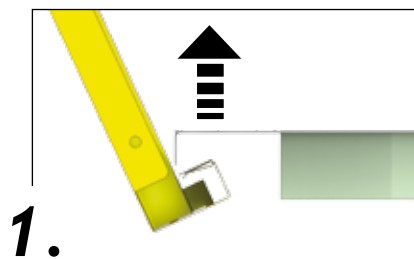

<b>3.</b>		2x	M4 x 10 	8x	4,2 x 13 	4x
-----------	--	----	--	----	---	----

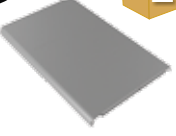

4.

 ⓑ	1x	M4 x 10	 ⓓ1	4x	4,2 x 13	 ⓓ1	3x
--	----	---------	---	----	----------	---	----

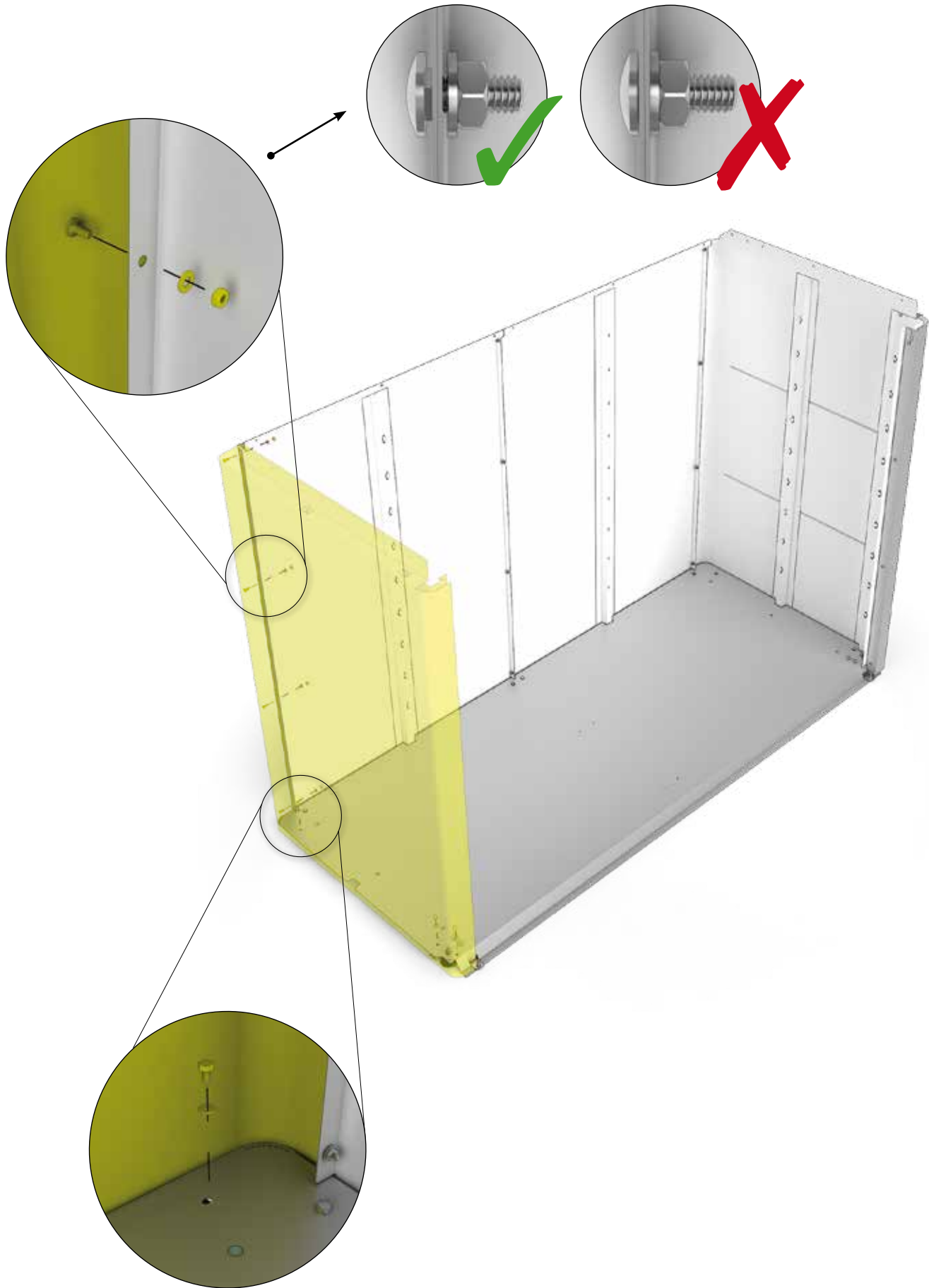

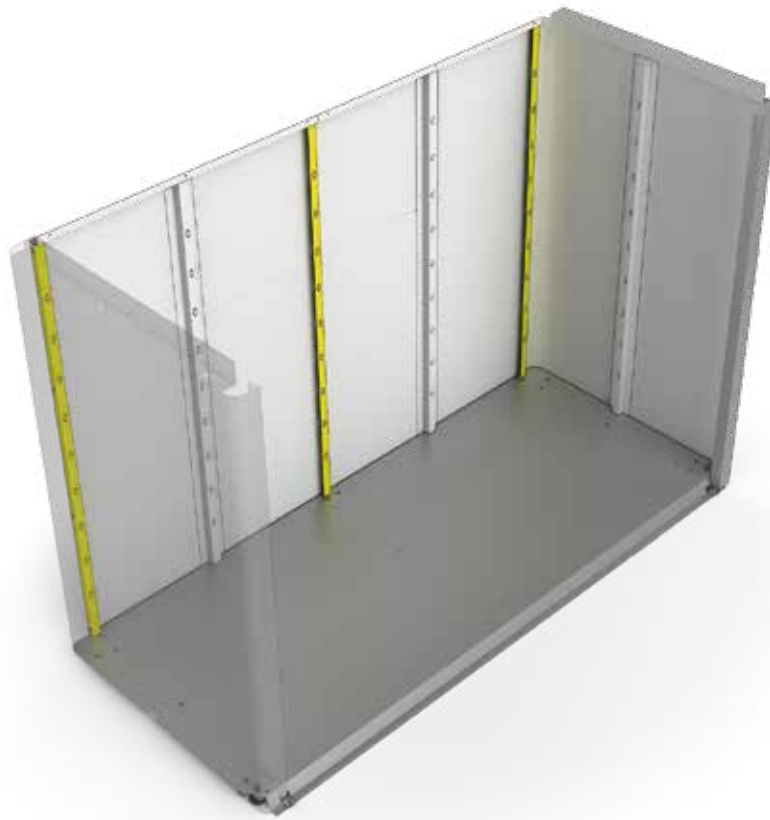
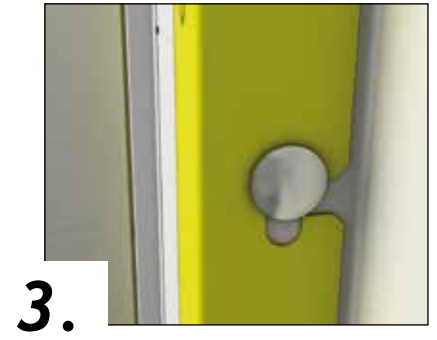
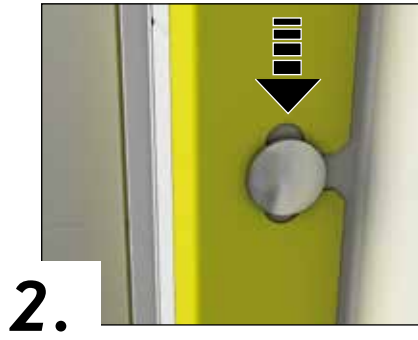

**!** optionales Zubehör - Accessories - Accessoires - toebehoor - Accessori - Accesorios



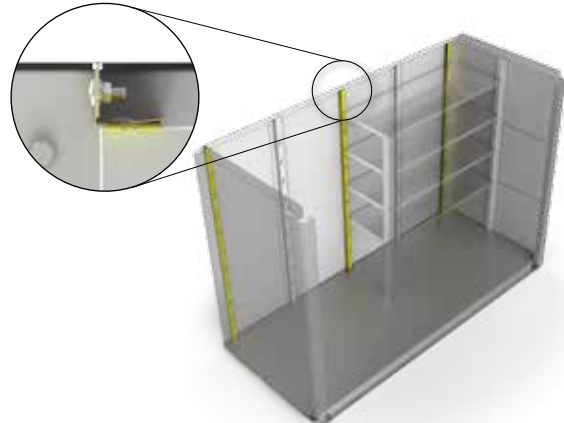
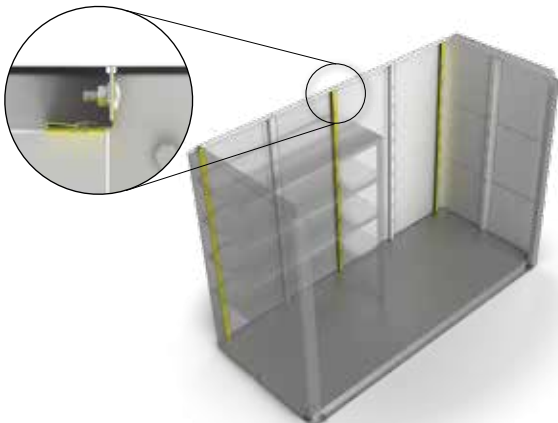

**Zwischenboden**

*Intermediate floors - Sol intermédiaire - tussenbodem - Ripiano intermedio - Balda intermedia*



optionales Zubehör - Accessories - Accessoires - toebehoor - Accessori - Accesorios



6.	 	1x	M4 x 10  	4x	 	2x
----	--	----	---	----	--	----

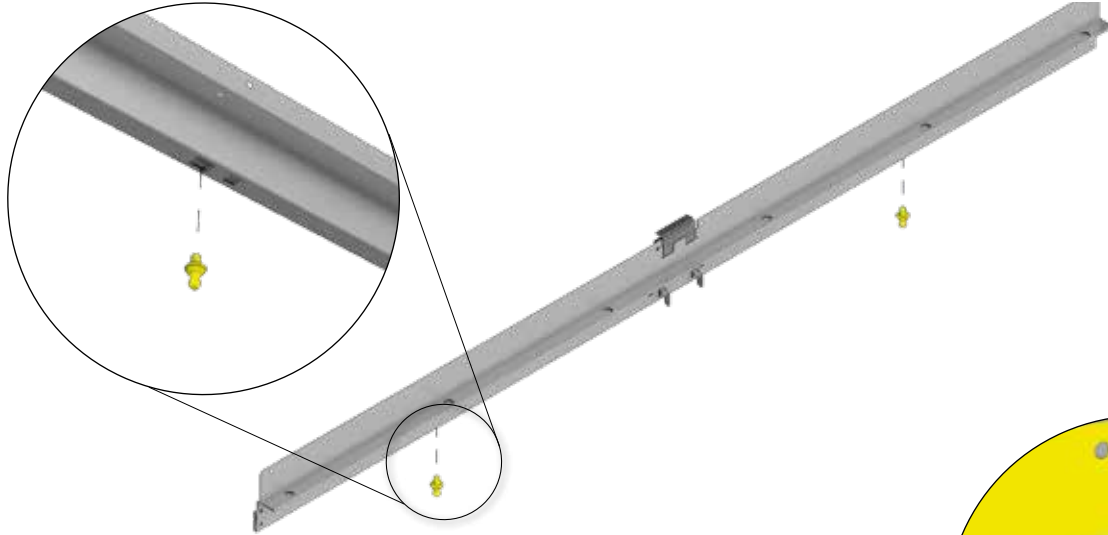

1.

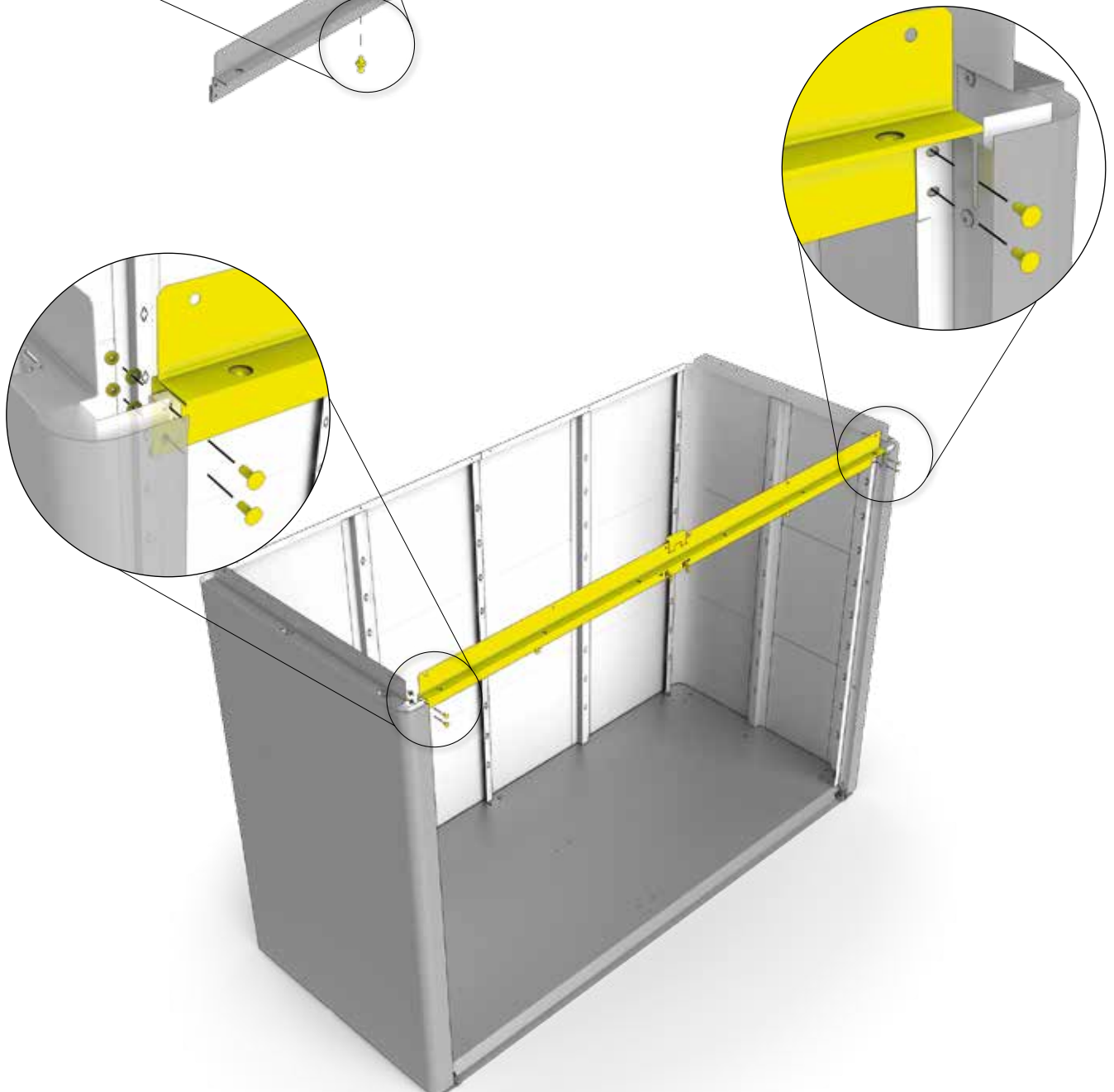

2.



7.

	1x		1x
---	----	---	----

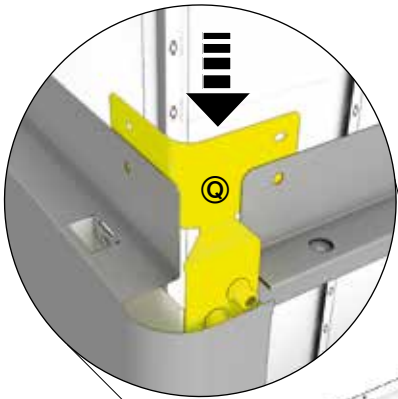

8.

2







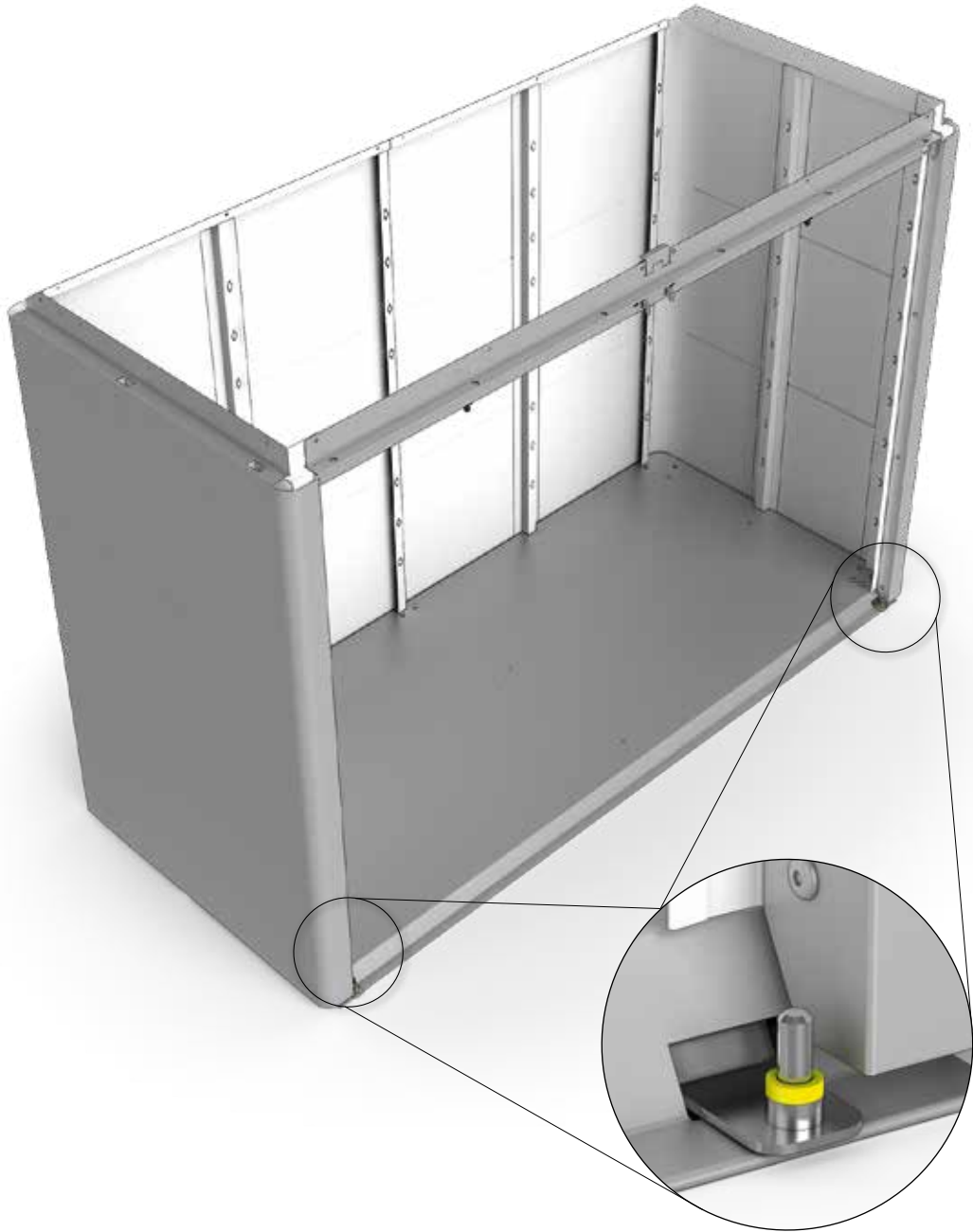



2x

D2



9.

 D2	2x	 D2	1x	 D2	1x
 N	1x	 O	1x	 S	1x
 T	1x	 D2	2x	 4,2 x 13 D1	10x

2x

1.

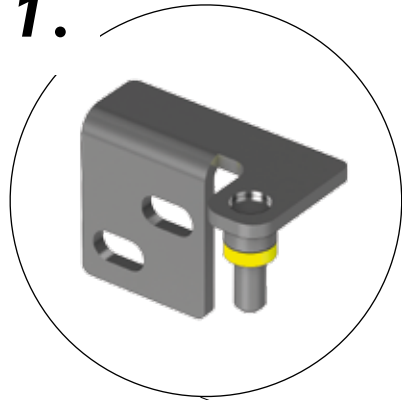

2.



4.

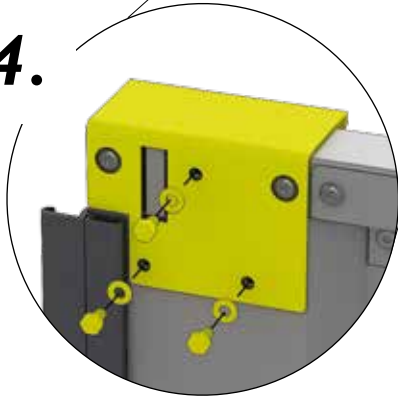

3.

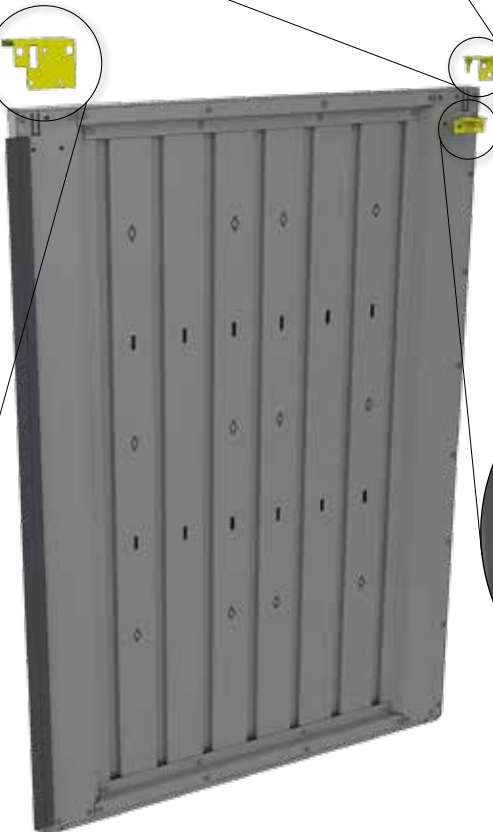
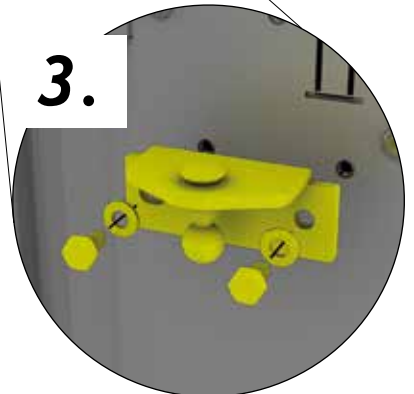

10.

M6 x 12



2

4x

D2



4. 5. 6.

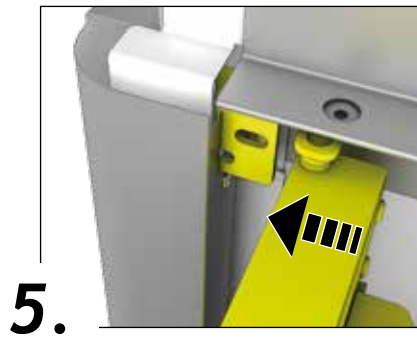
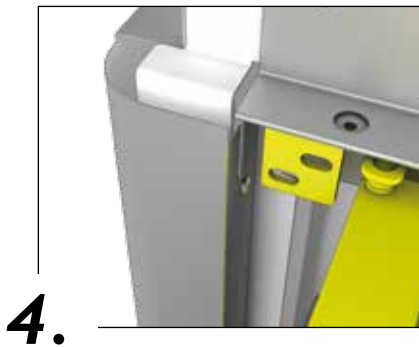
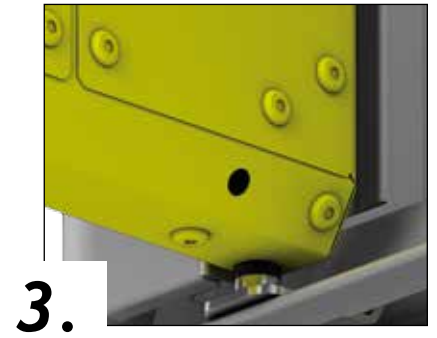
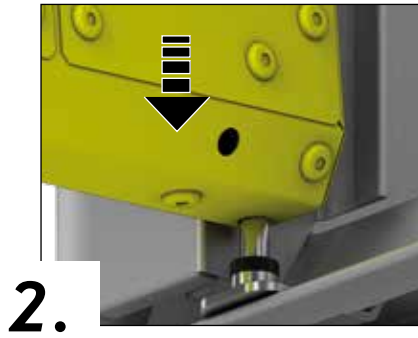
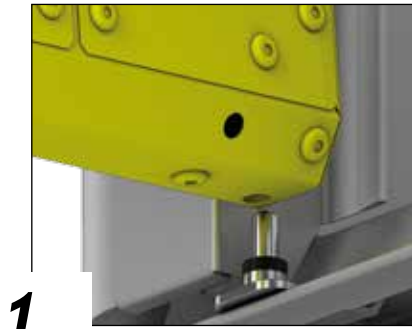

1. 2. 3.



11.

 Ⓟ	1x	M4 x 10	 ⓍD1	4x
--	----	---------	---	----

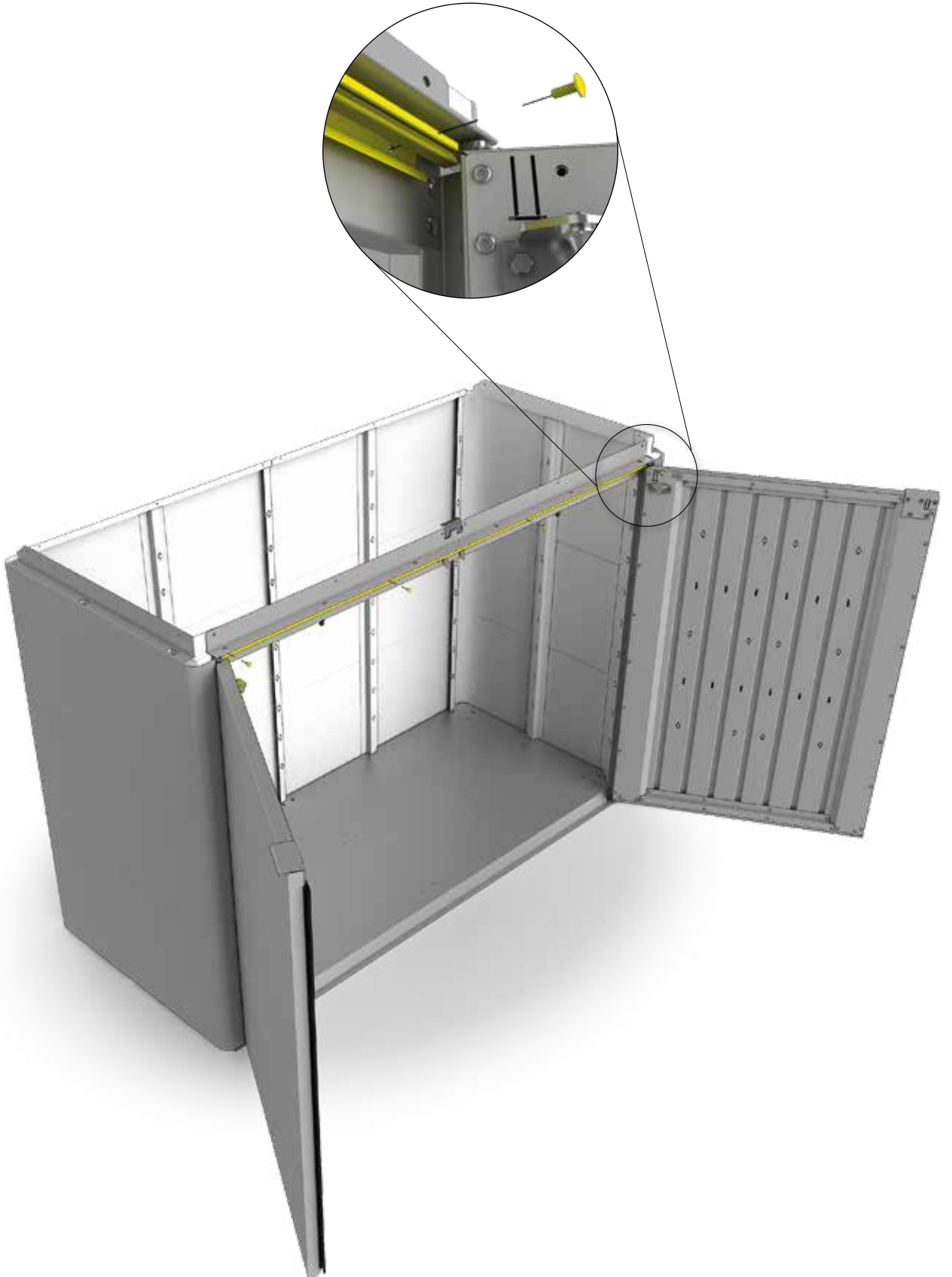

12.

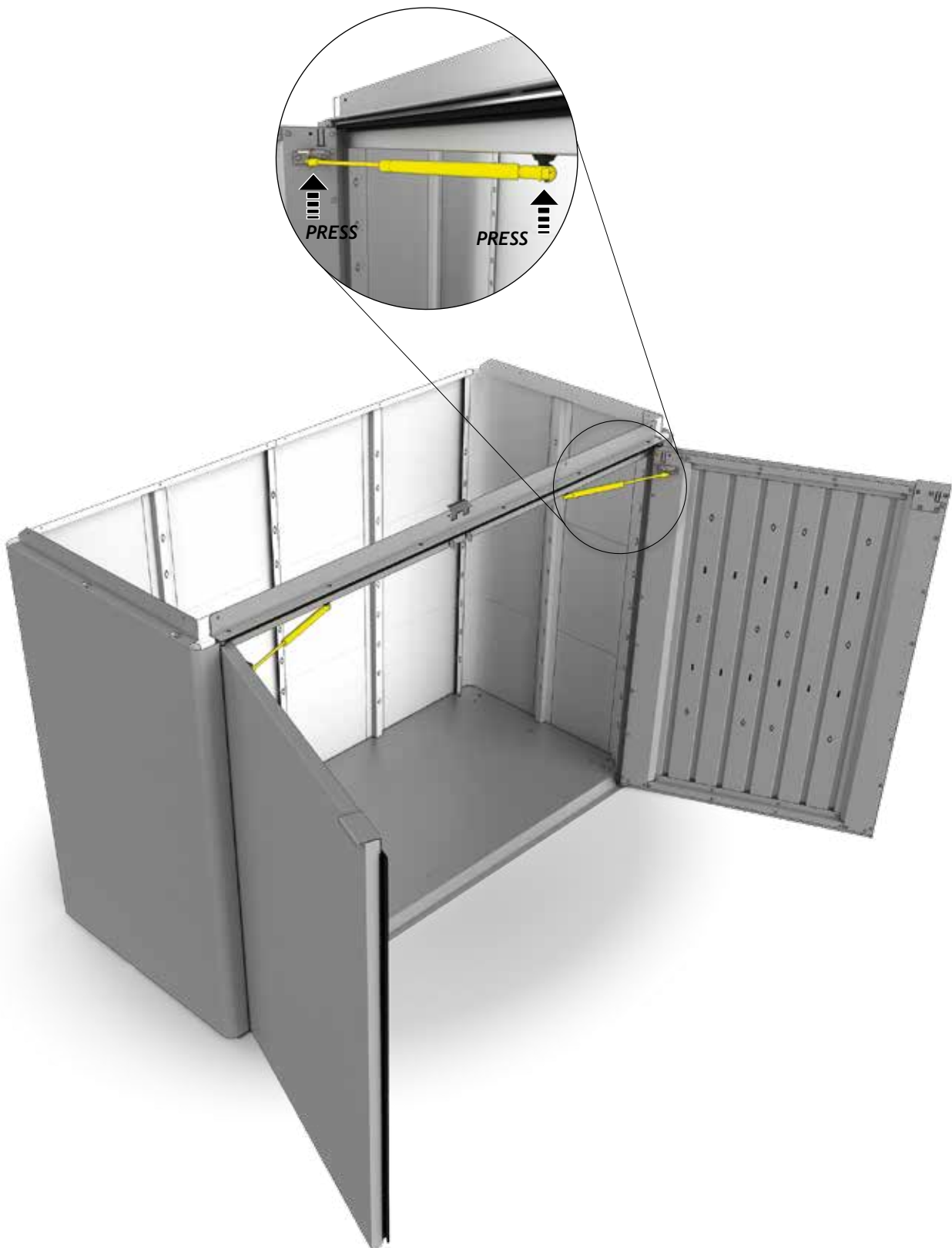

13.

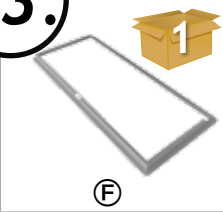
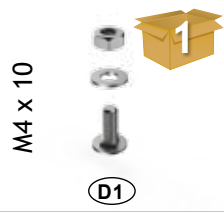
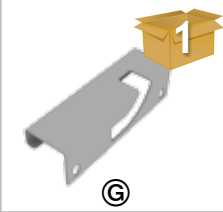
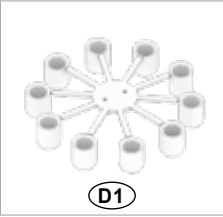
 ⓕ	1x	M4 x 10  ⓓ1	16x	 ⓖ	1x
 ⓓ1	4x				

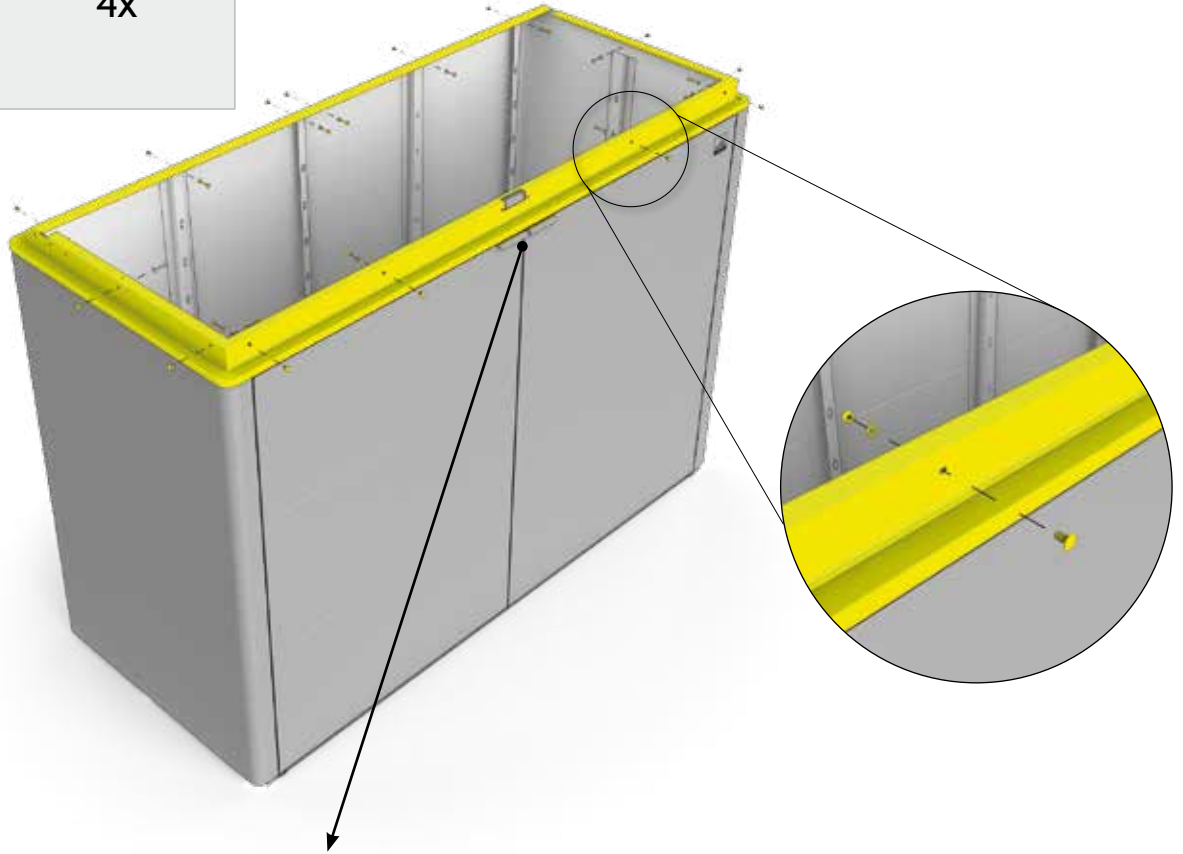

1.

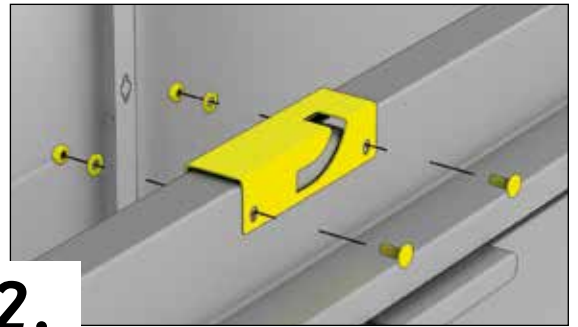

2.





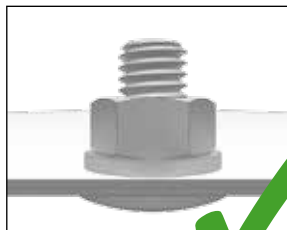

**Ziehen Sie jetzt alle Schraubenverbindungen fest an!**

*Tighten now all nuts and connections securely! - Serrez maintenant les vis à fond!  
- Draai nu alle schroeven vast! - Ahora puede apretar y fijar todos los tornillos  
y tuercas - Adesso serrare a fondo tutti i dadi!*







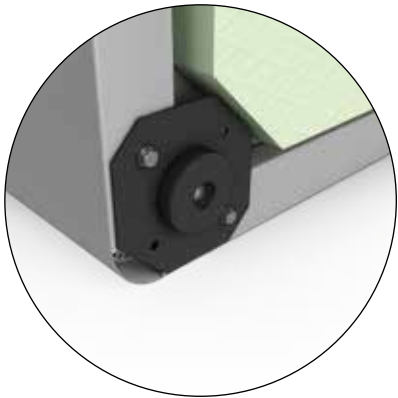
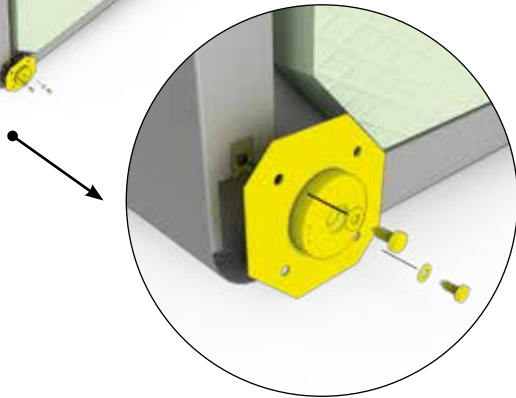
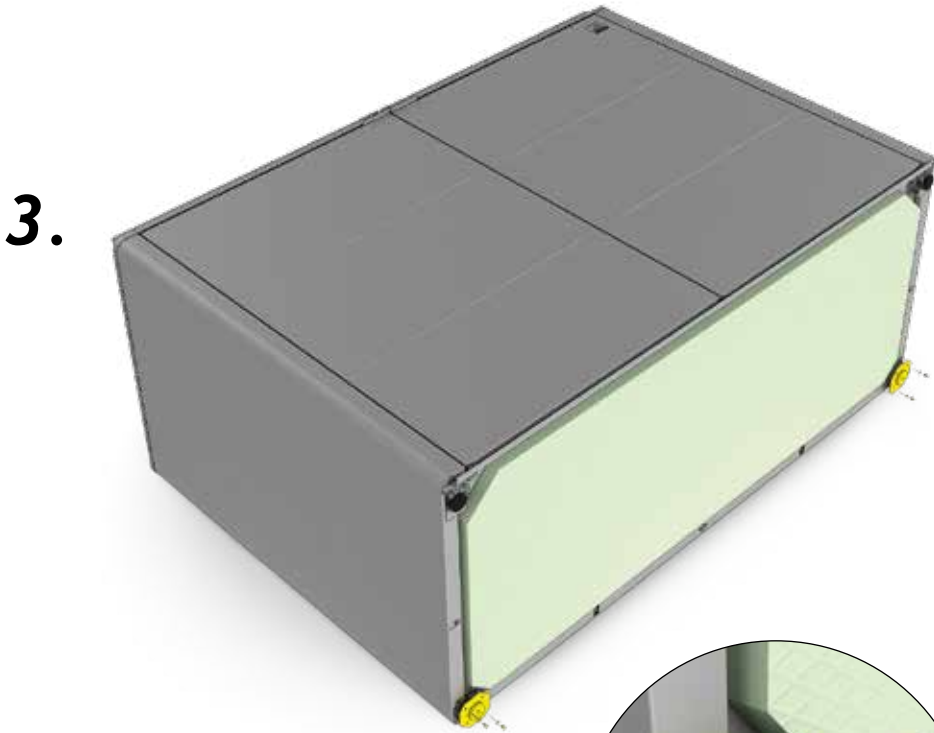
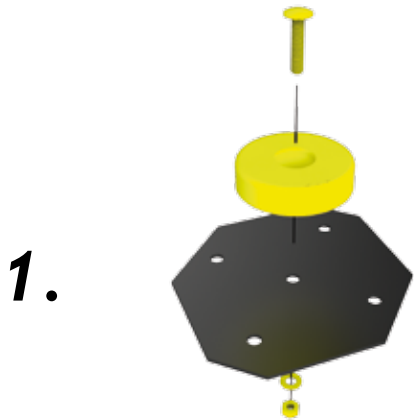

14.

 Ⓚ	2x	 ⓓ2	2x	M4 x 18  ⓓ1	2x
 ⓓ1	4x				

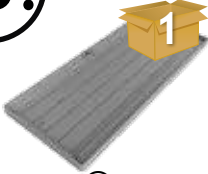

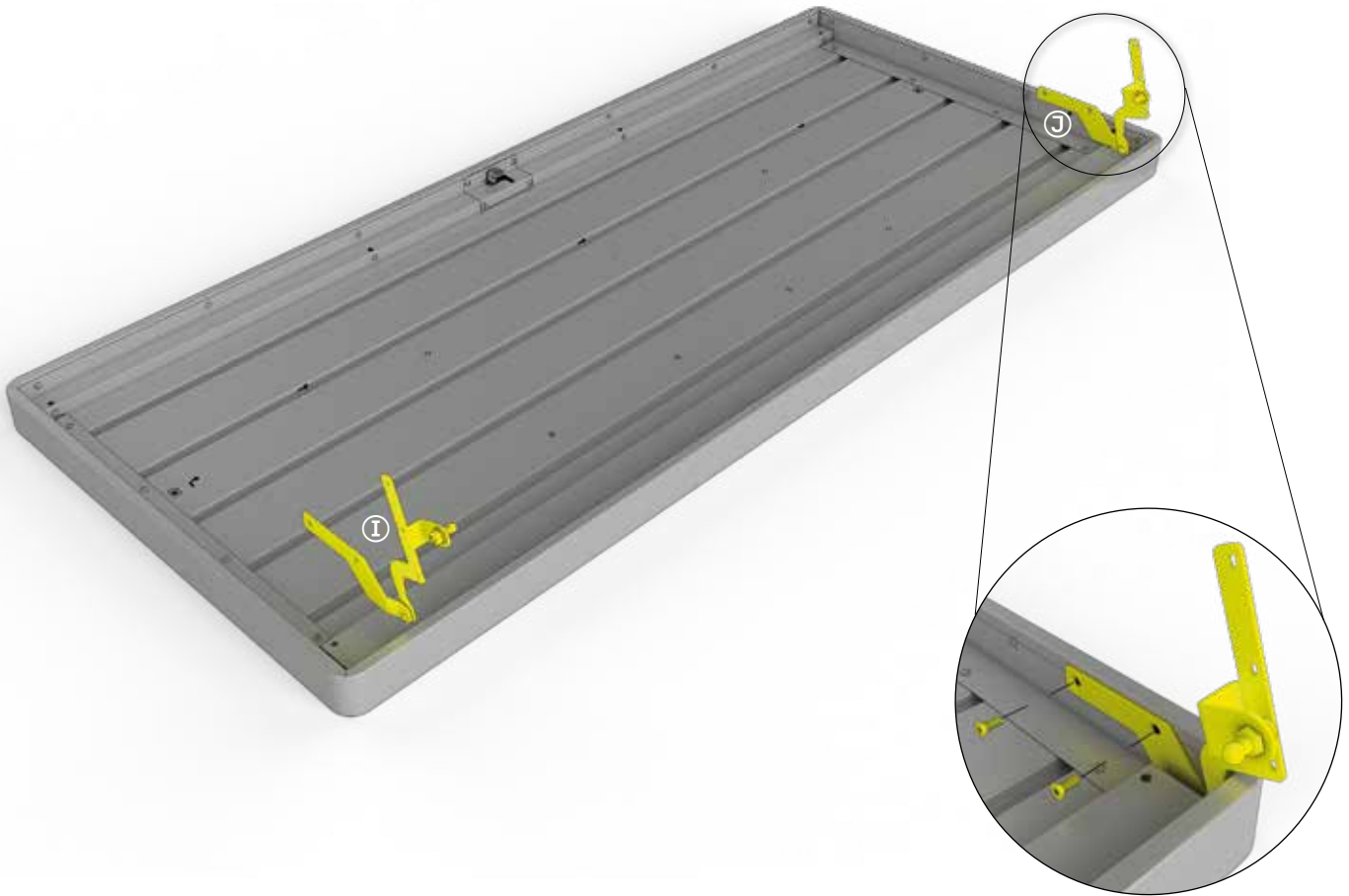

15.

 Ⓕ	1x	 Ⓖ	1x	 Ⓗ	1x
M6 x 16  Ⓓ1	4x				



16.

 D1	6x	 D1	2x
---	----	---	----

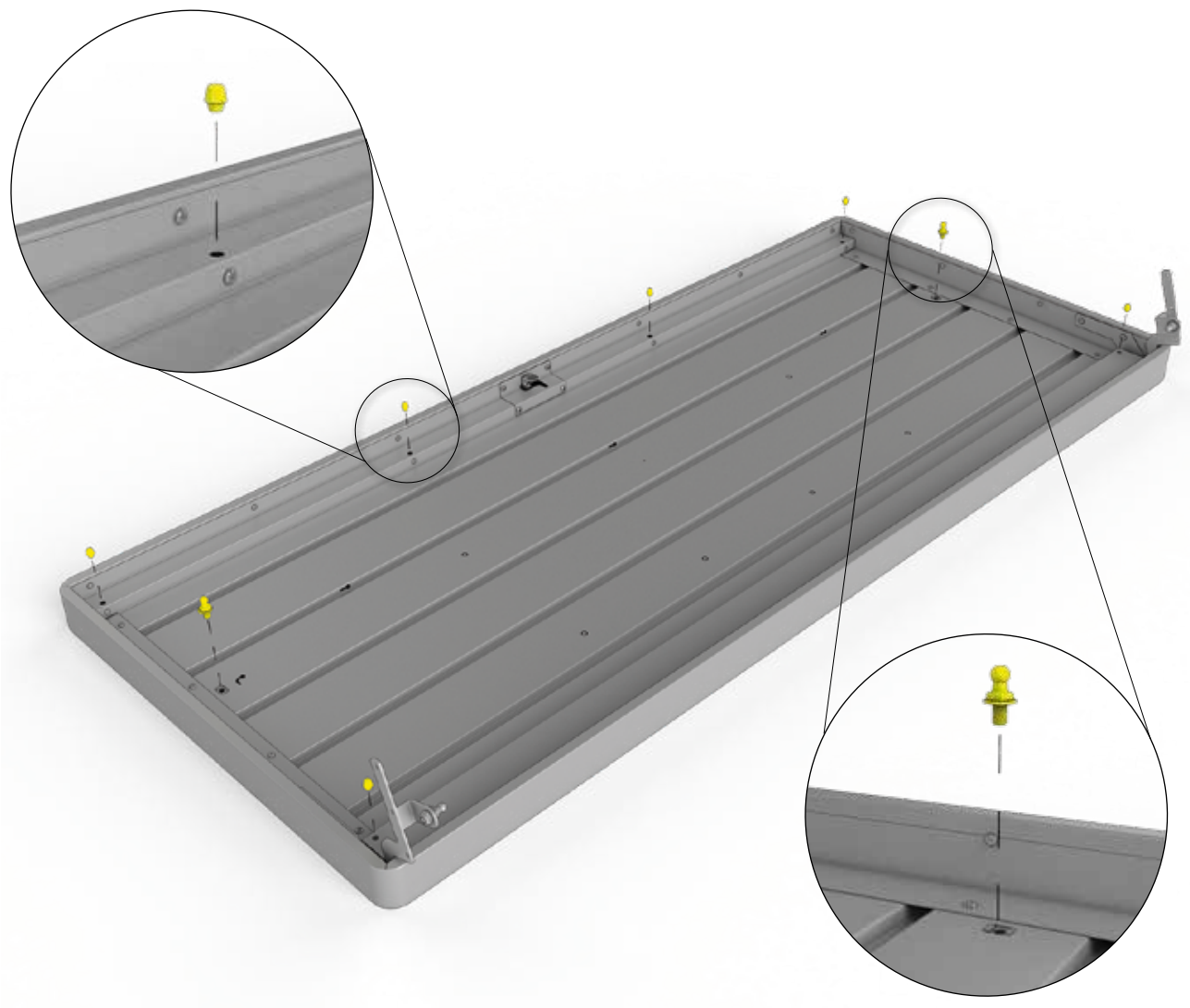

17.

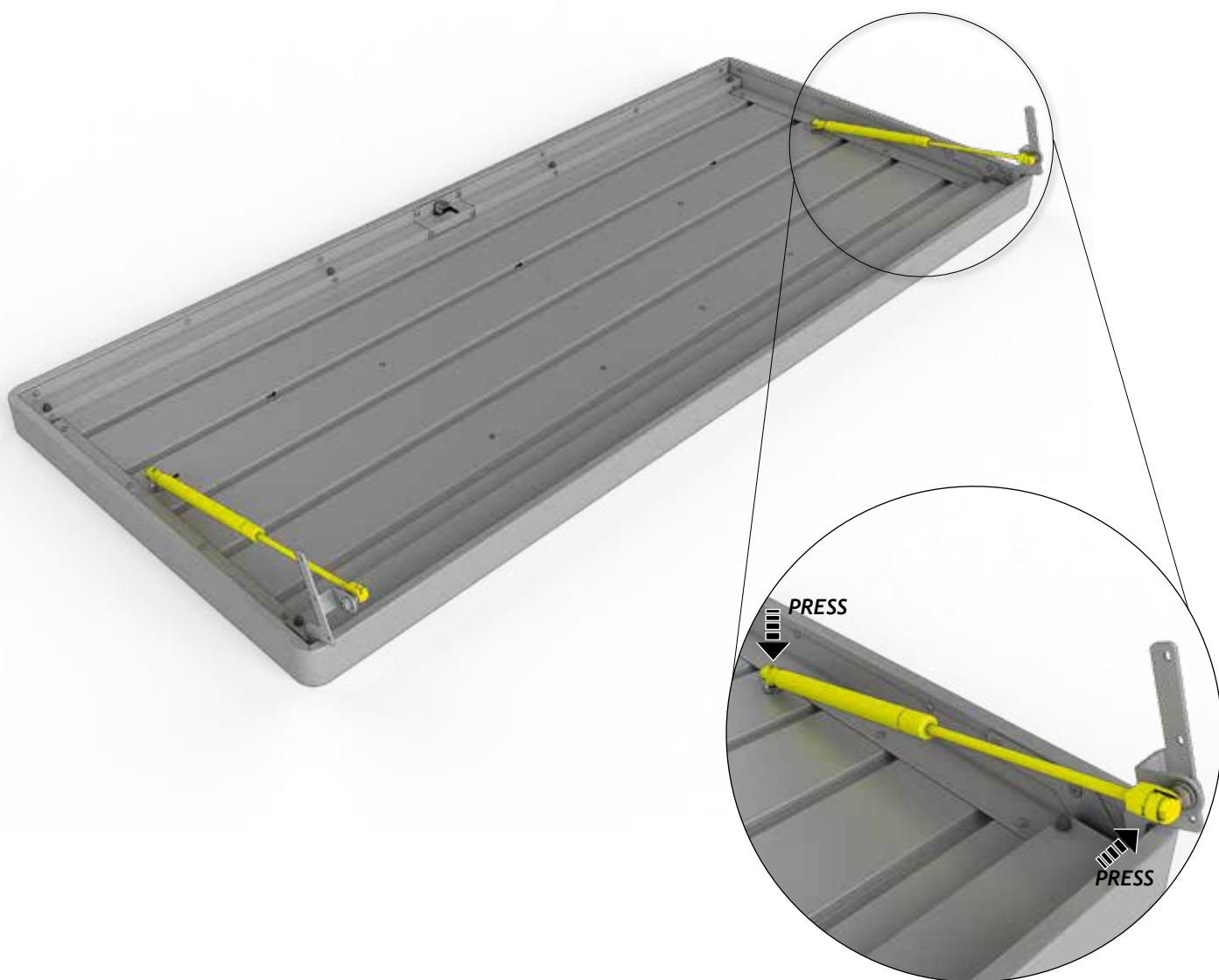
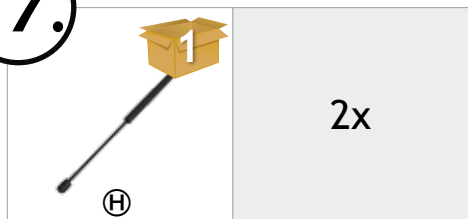

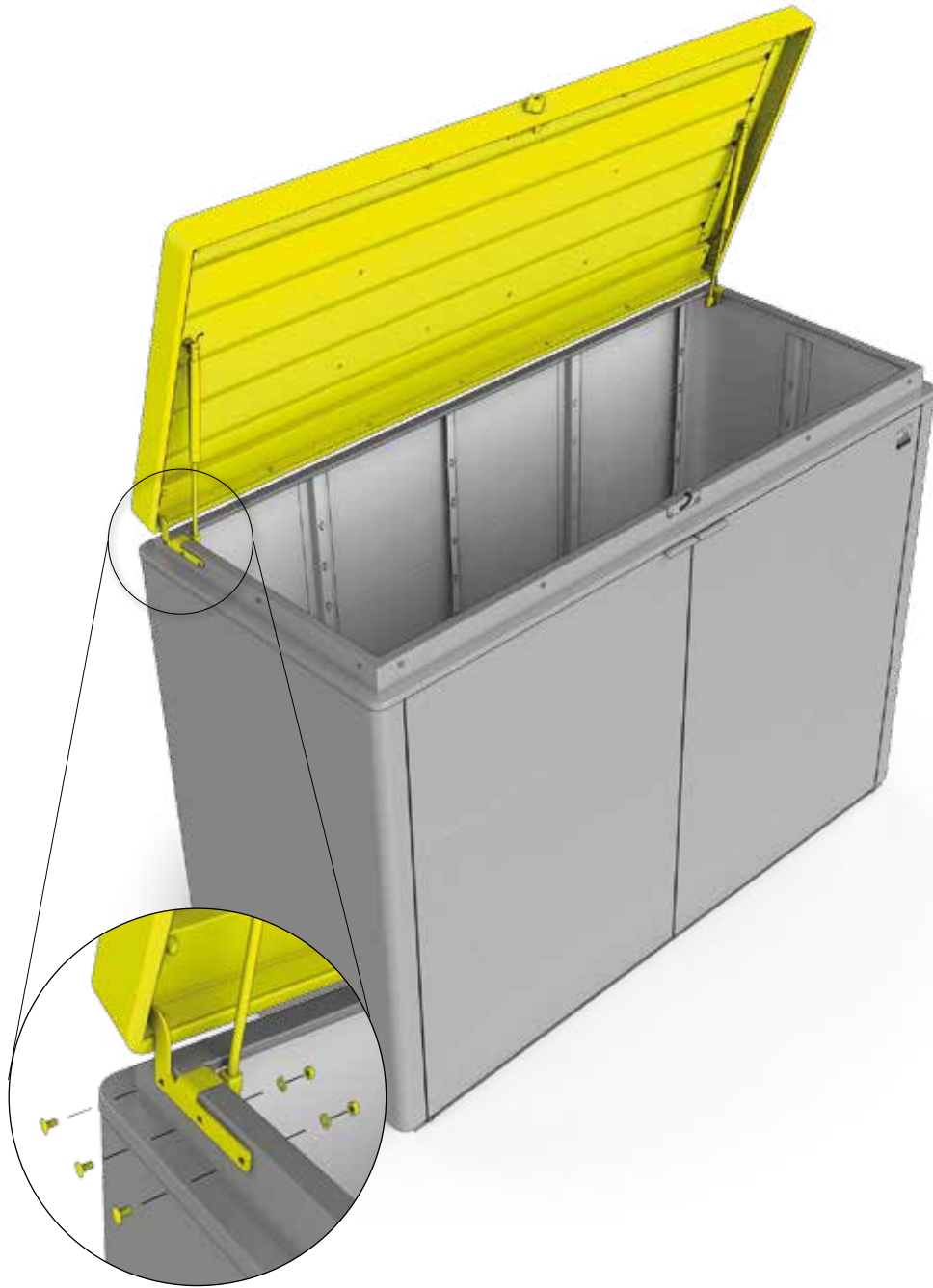
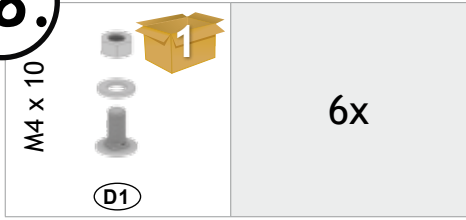

**18.**

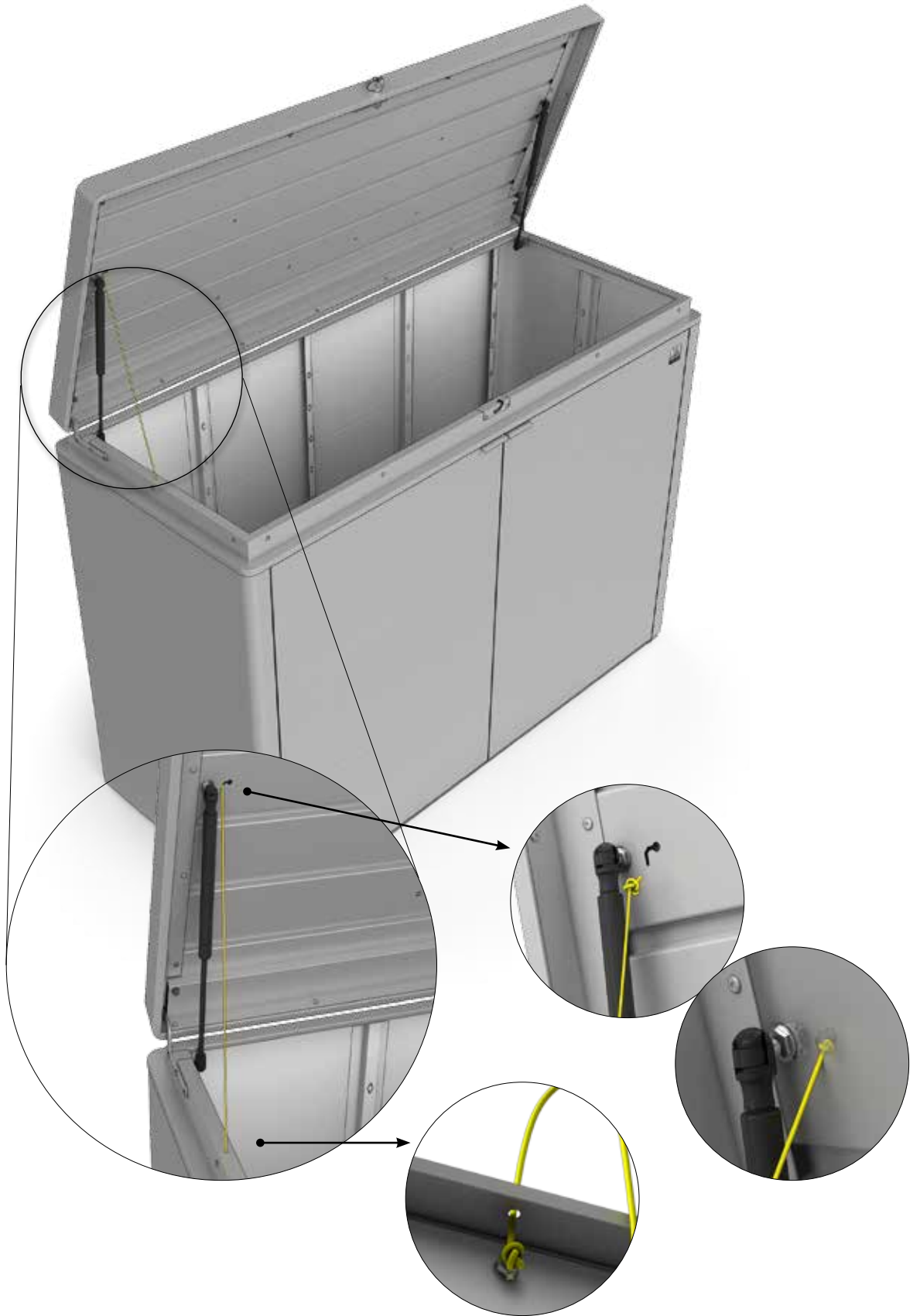
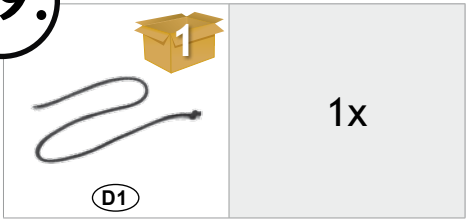

19.



20.

 2	2x	 D2	1x
--	----	---	----

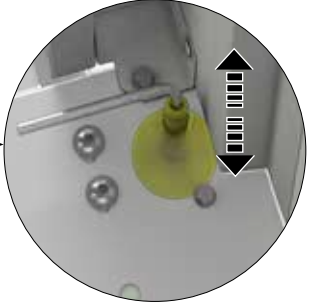
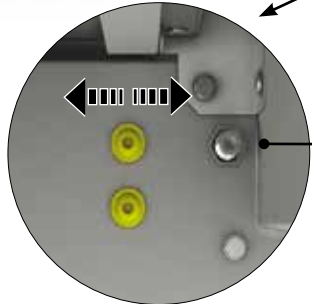
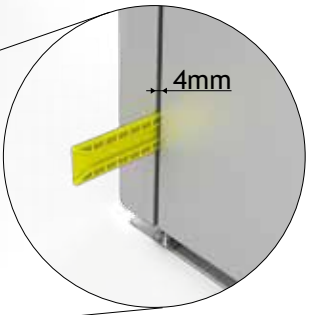
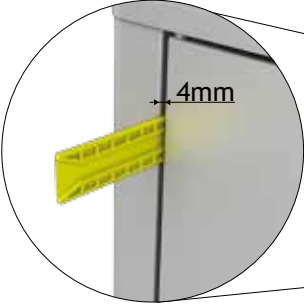
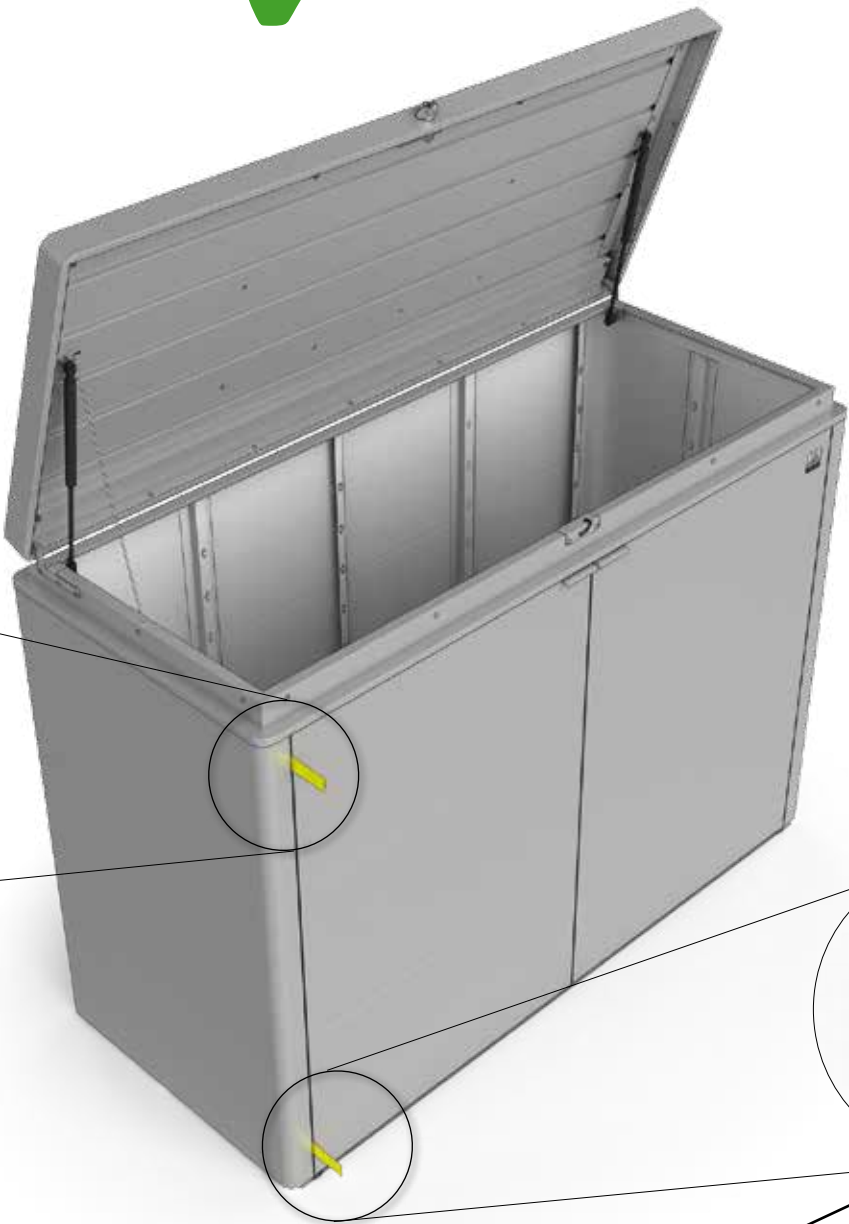
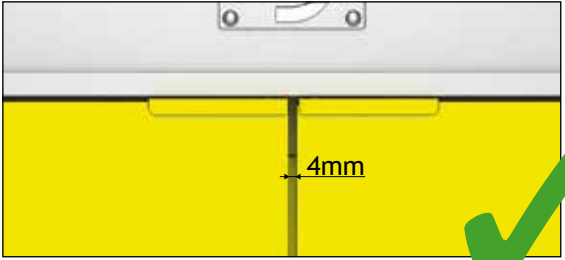

21.

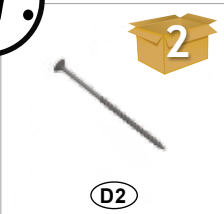
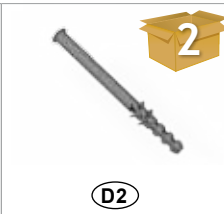
 D2	4x	 D2	4x
---	----	--	----

1.

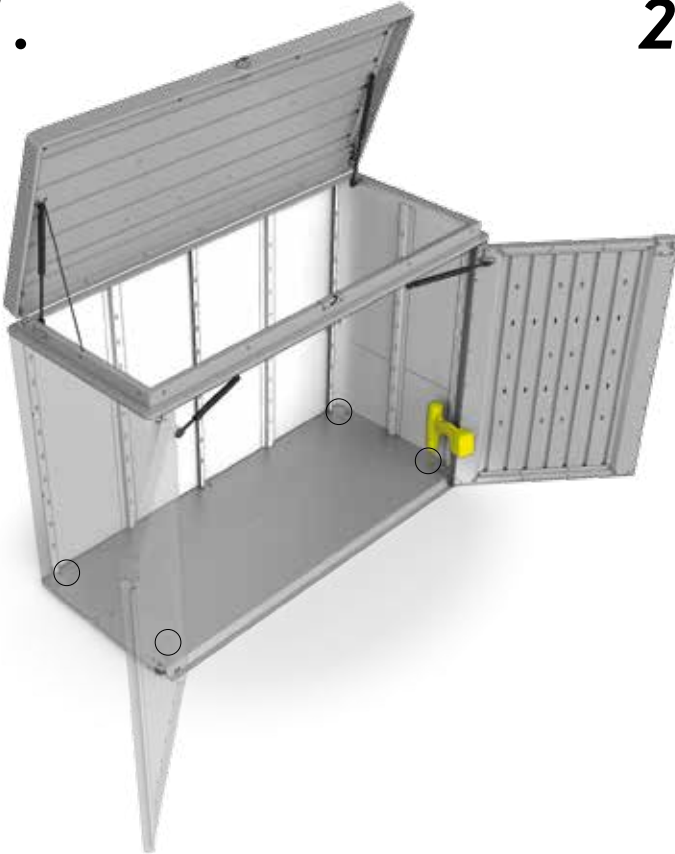

2.

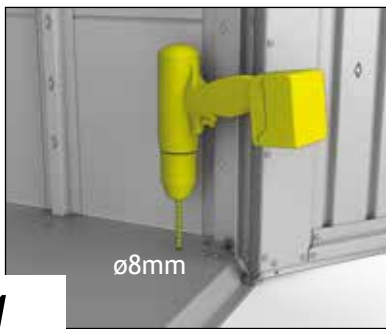

1.

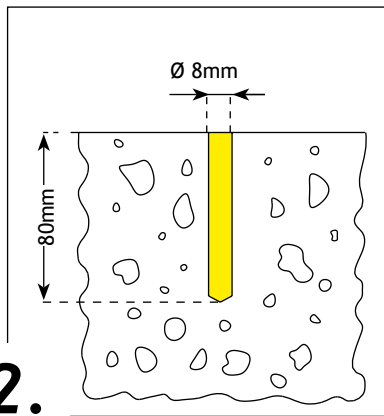

2.

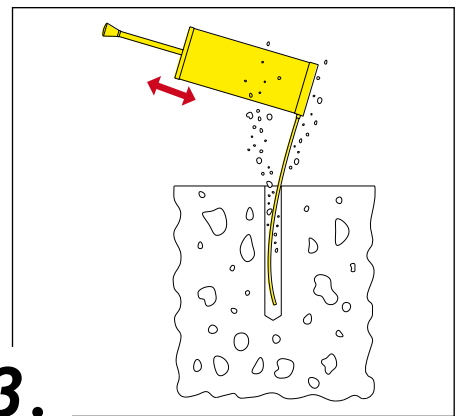

3.

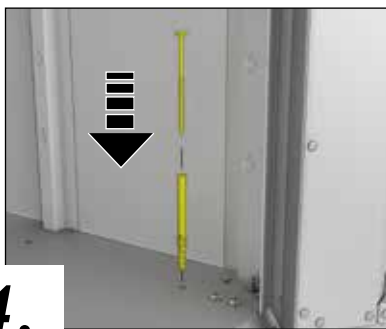

4.



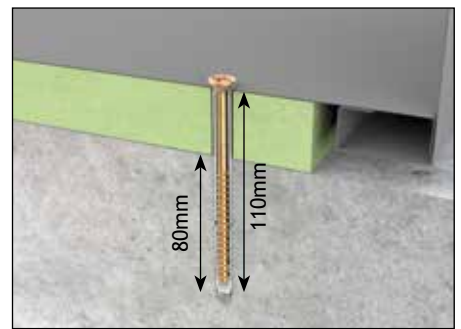

5.





22.

 D2	1x	 D2	1x	 D2	1x
---	----	---	----	---	----

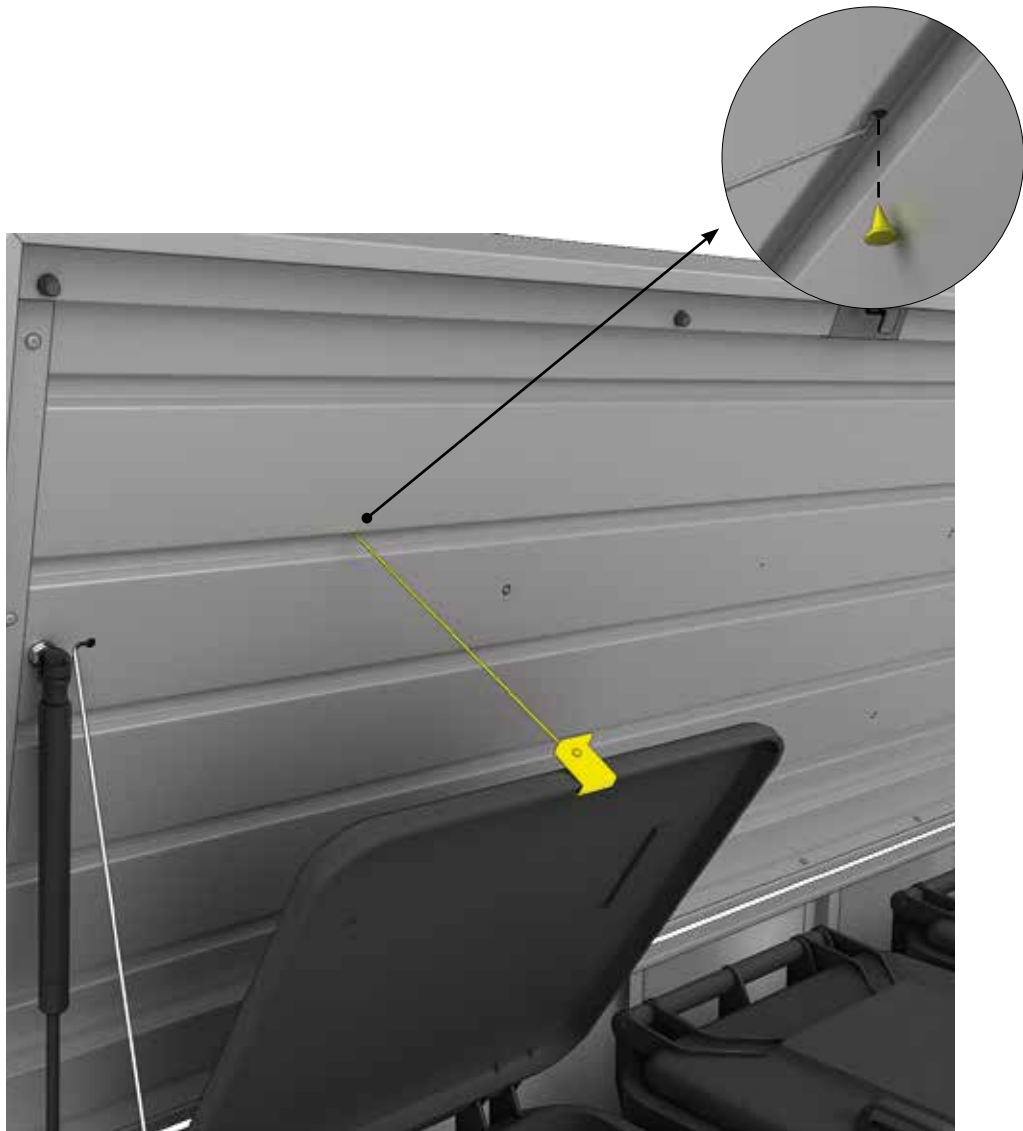

23.

2



D2

4x

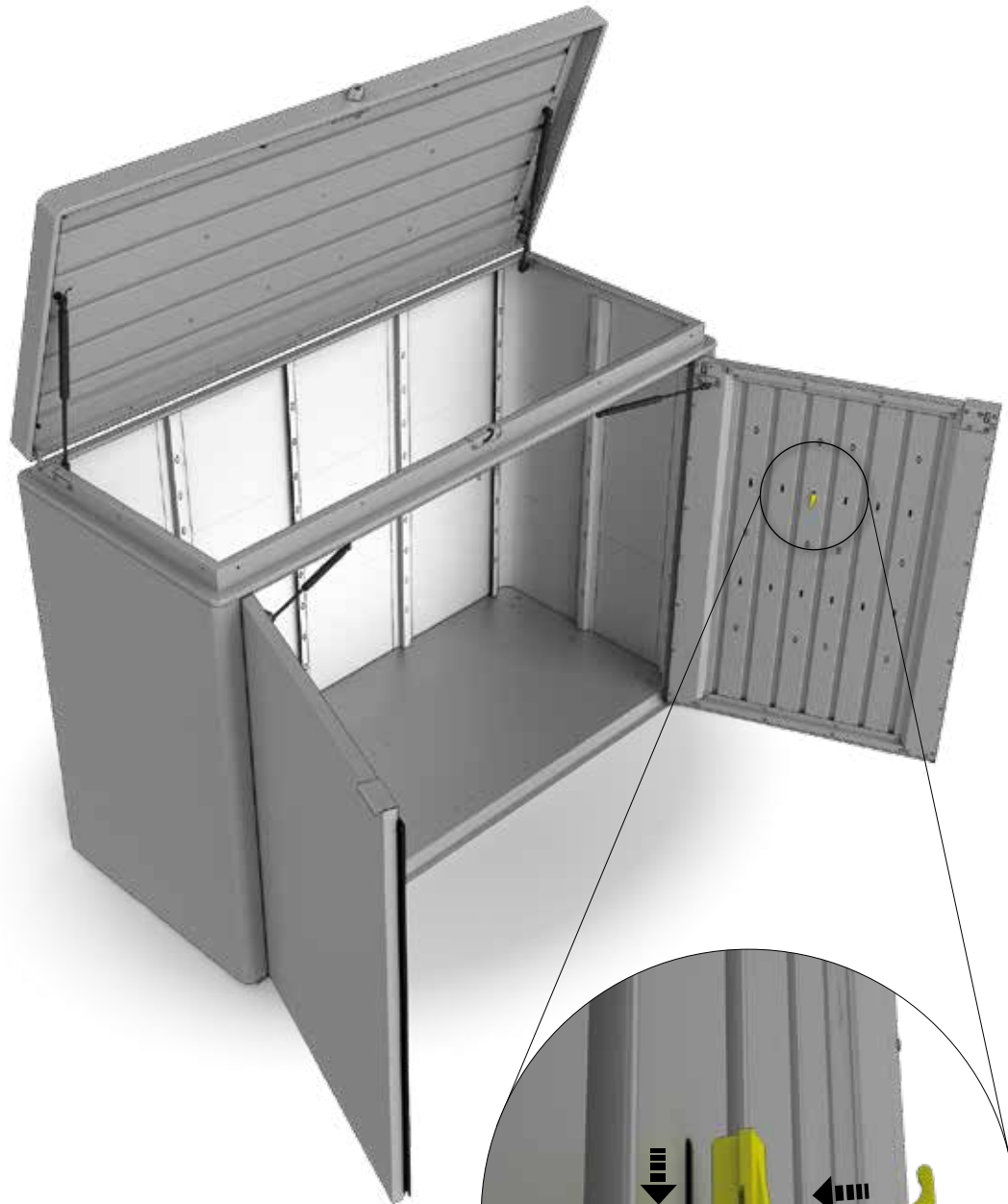



## Werkzeughalter

Tool holders - Supports de petits outils - Werktuighouders - Portautensili - Soportes para herramientas

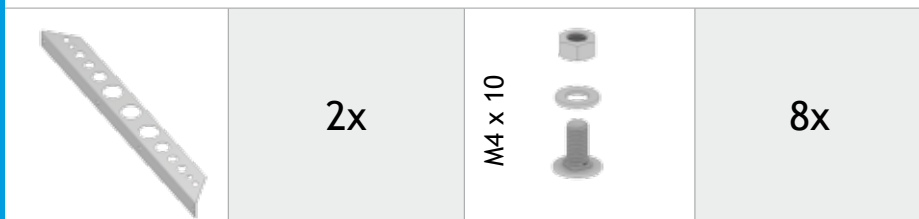

1.

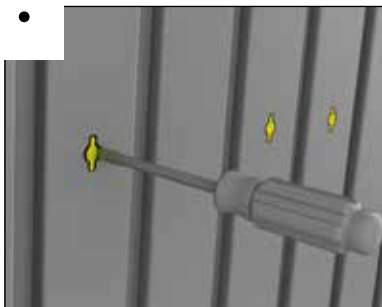

2.

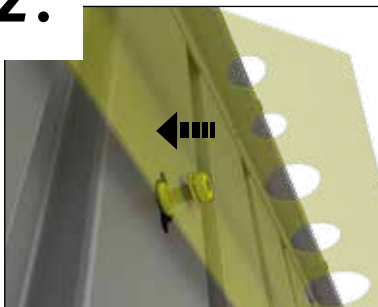

3.

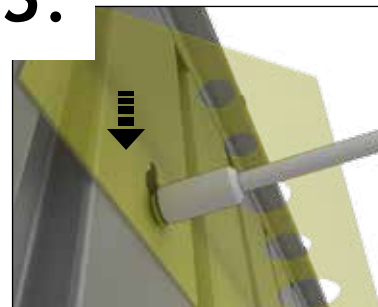



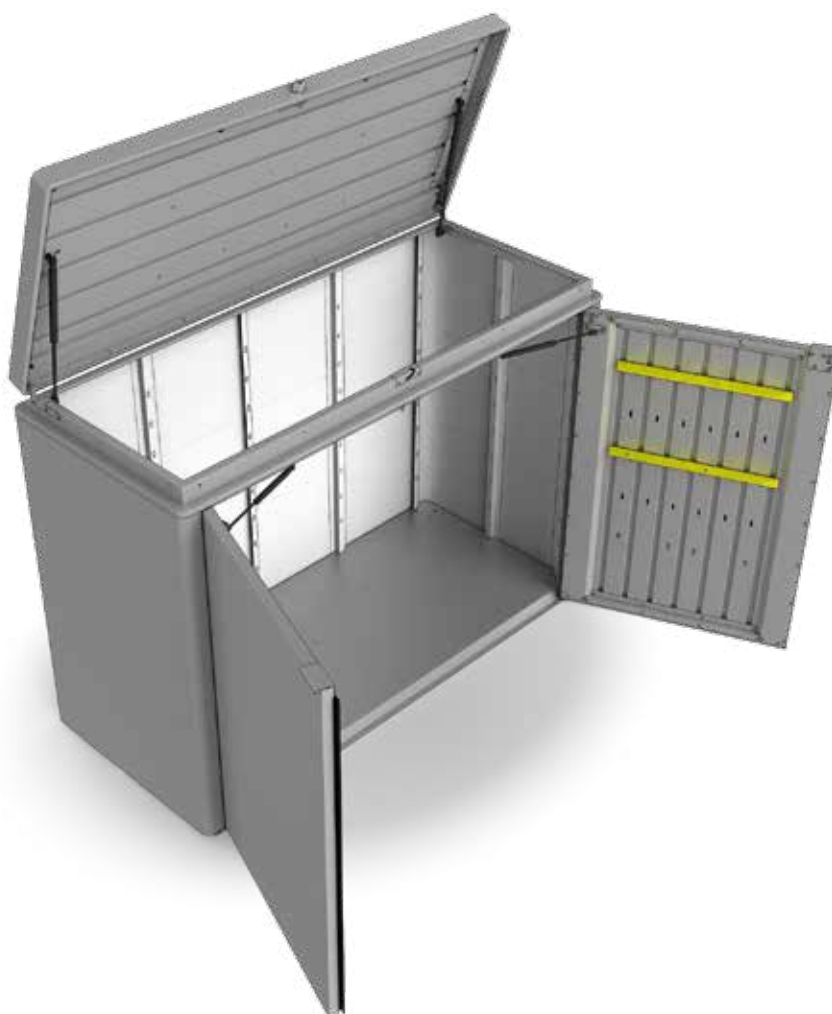

4.





## Zwischenboden Opt. 1

Intermediate floors - Sol intermédiaire - tussenbodem - Ripiano intermedio - Balda intermedia

	4x		1x		1x
M4 x 10 	26x	4,2 x 13 	1x		

1.

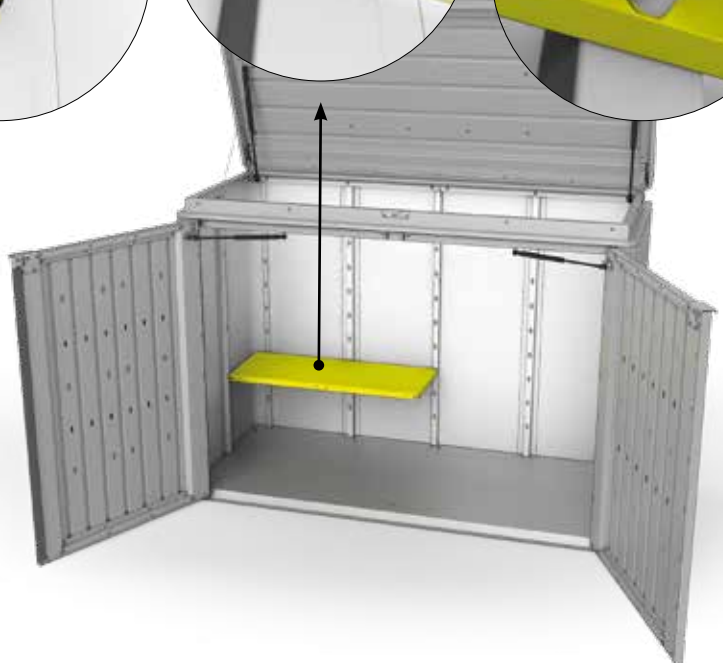
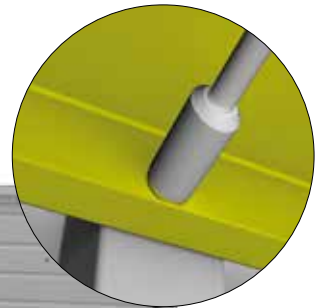
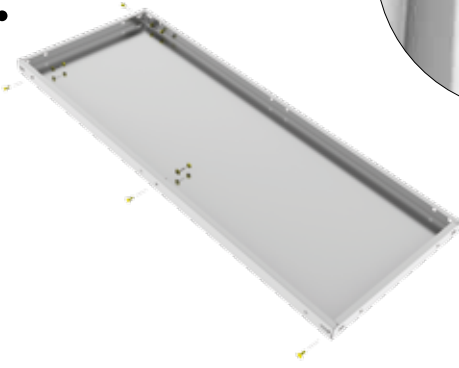

2.

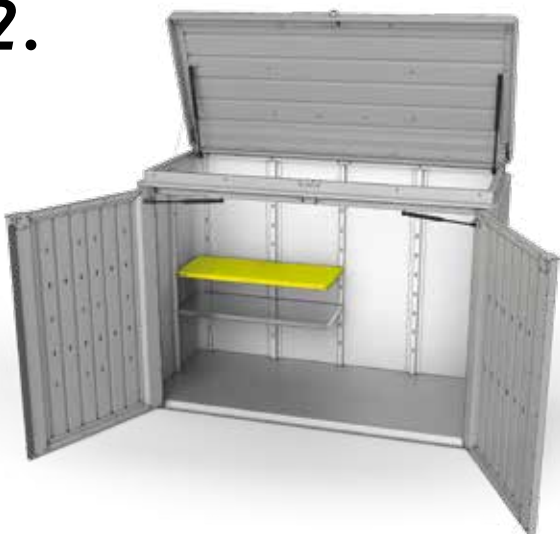

3.

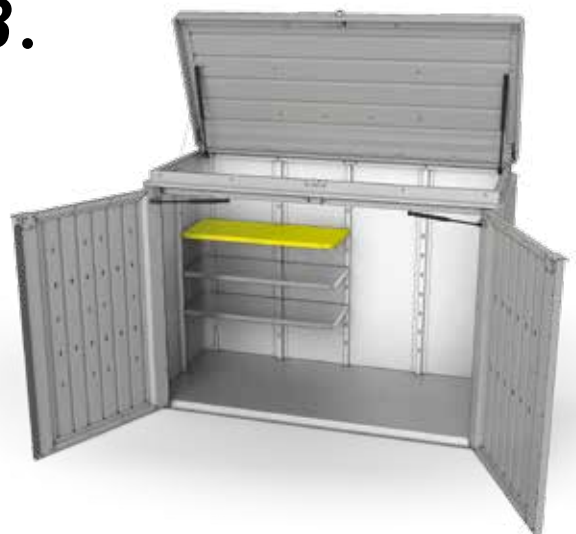

4.



5.

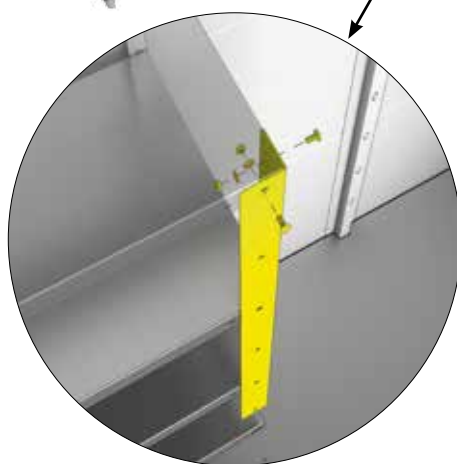
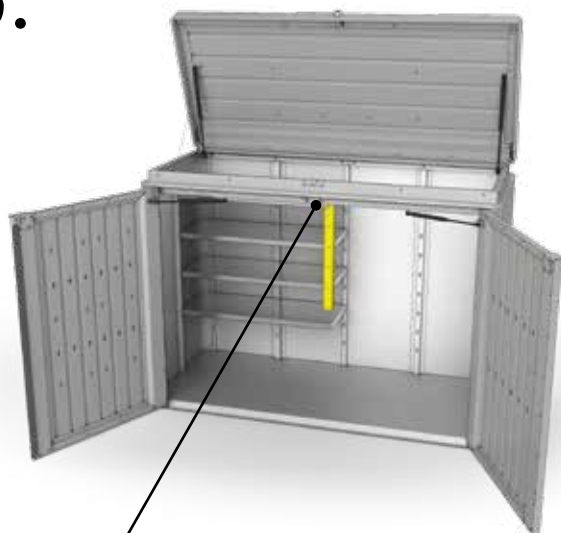

6.

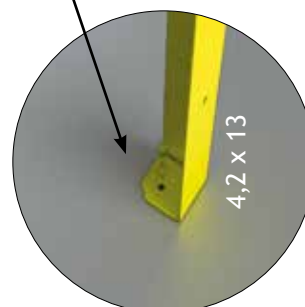
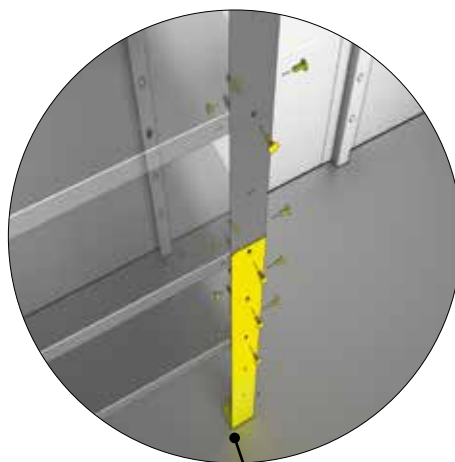
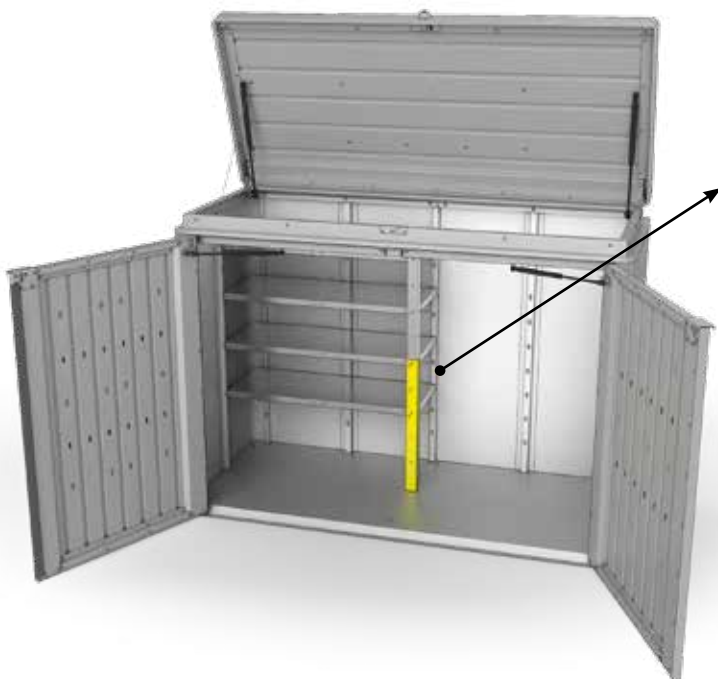



## Zwischenboden Opt. 2

Intermediate floors - Sol intermédiaire - tussenbodem - Ripiano intermedio - Balda intermedia

	4x		1x		1x
M4 x 10 	24x	4,2 x 13 	1x		

1.

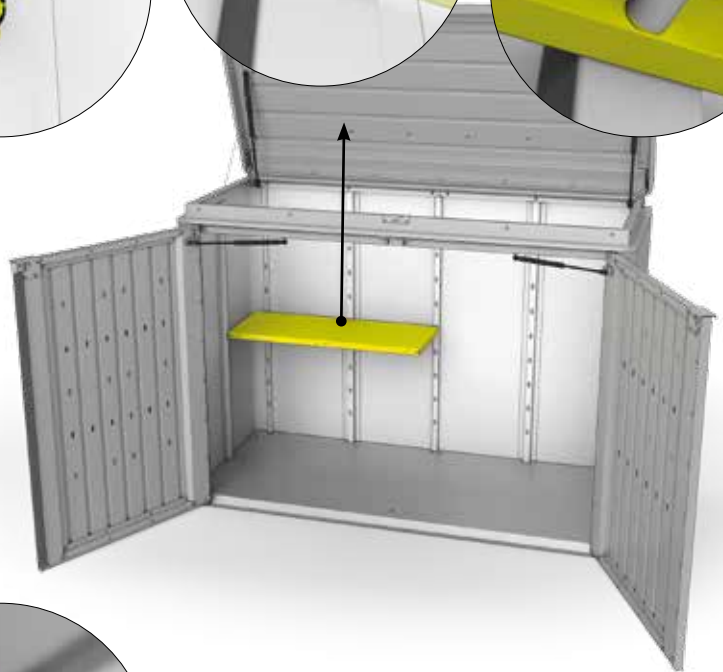
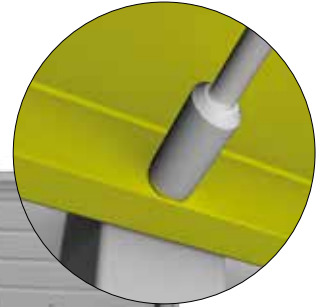
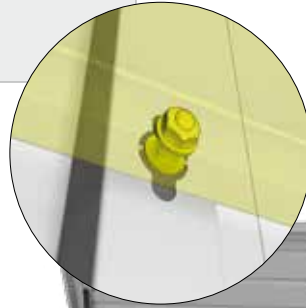
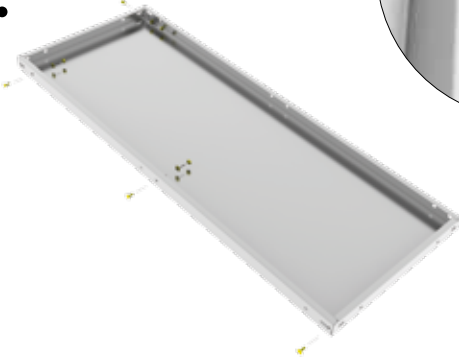

2.

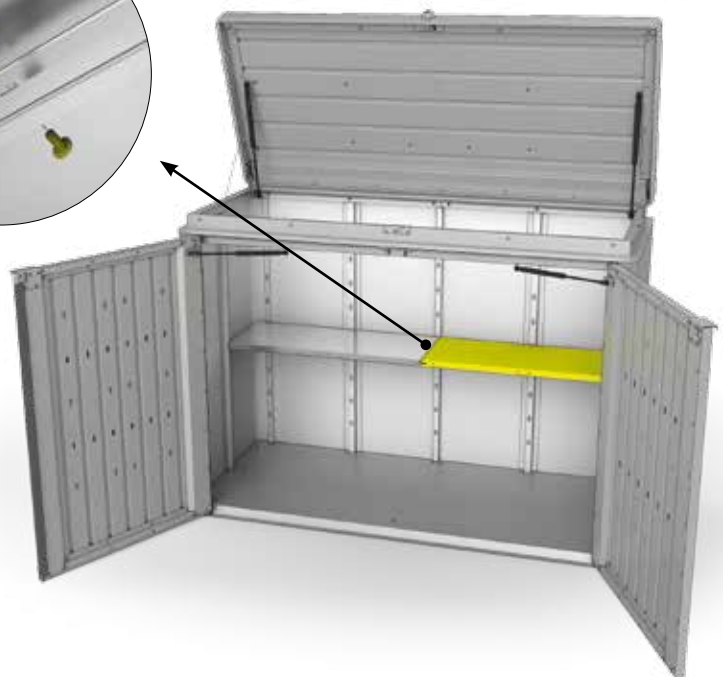
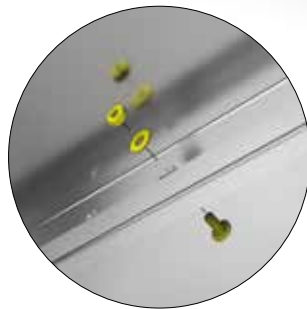
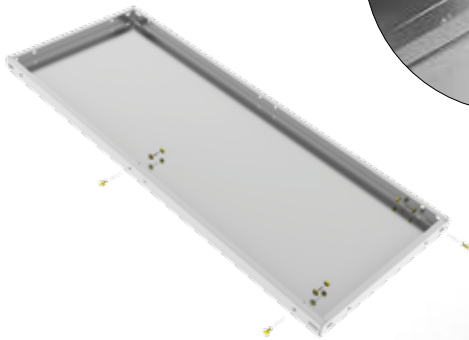

3.



4.



5.

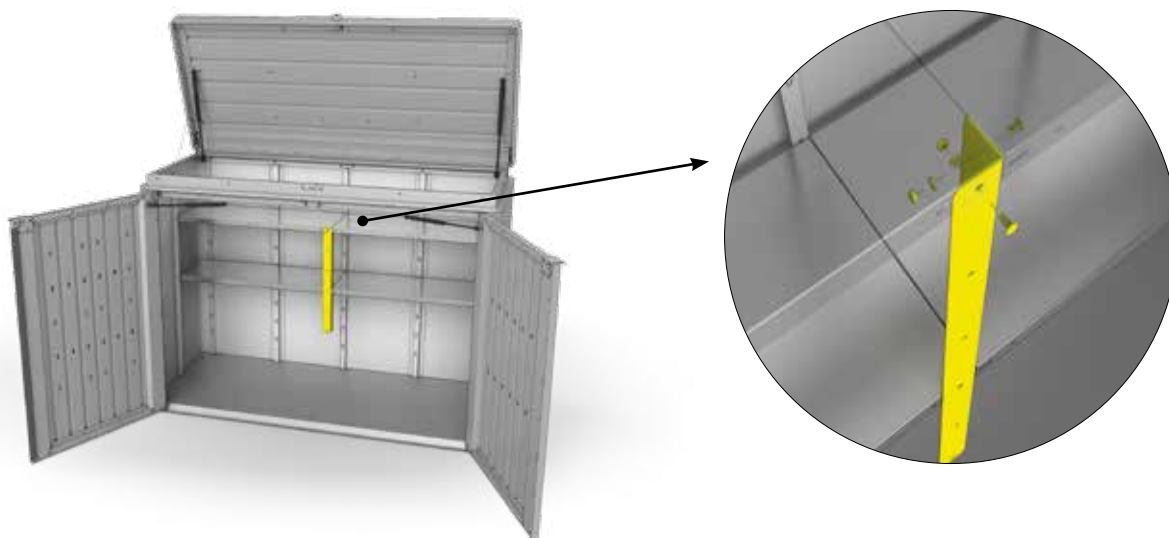

6.

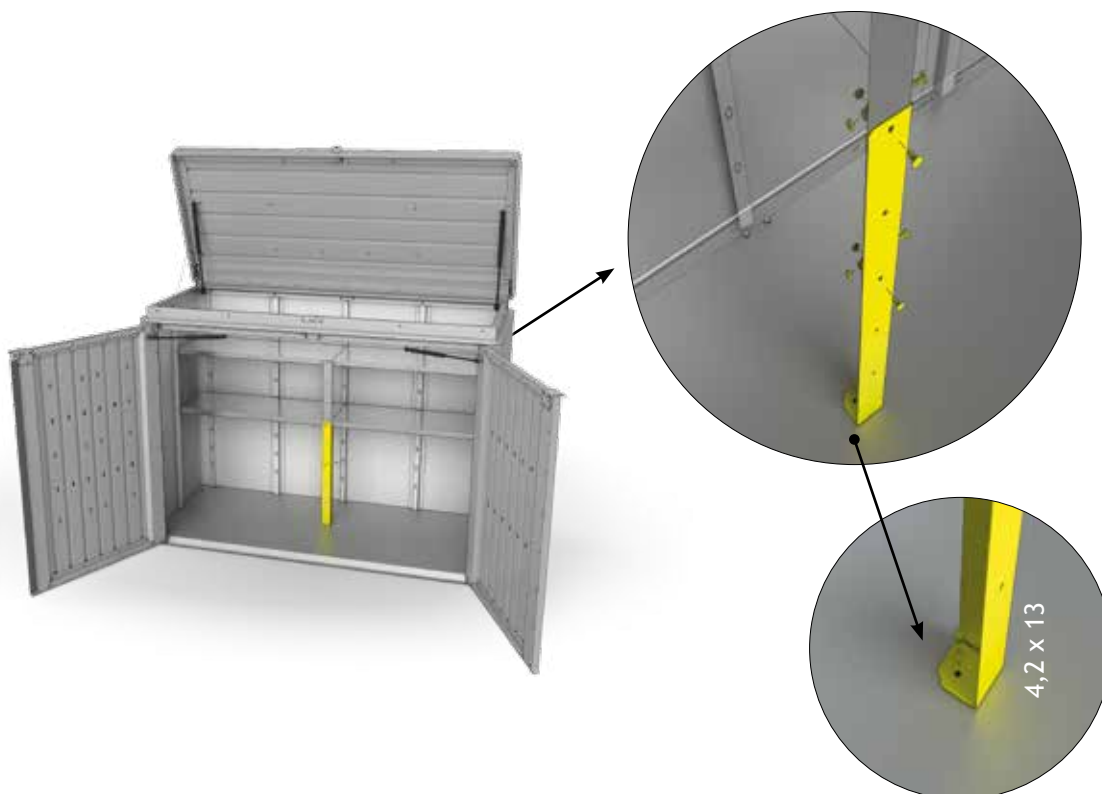



### Zwischenboden Opt. 3

Intermediate floors - Sol intermédiaire - tussenbodem - Ripiano intermedio - Balda intermedia

	1x		1x		1x
M4 x 10 	28x		1x	4,2 x 13 	1x

1.

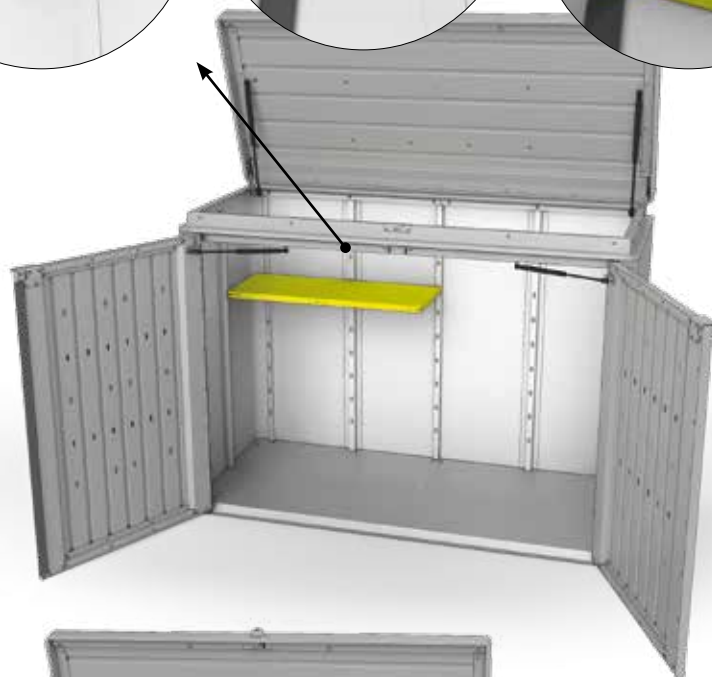
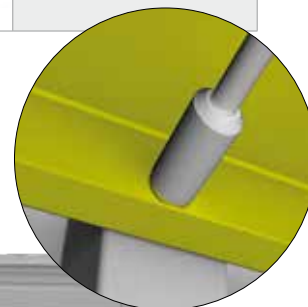
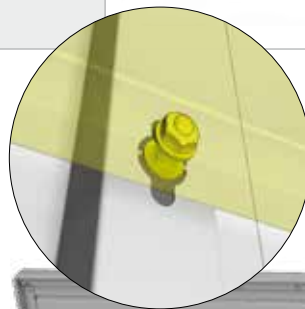
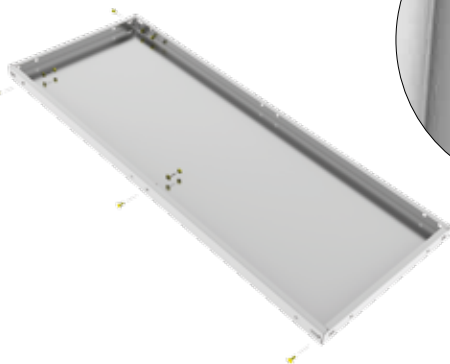

2.

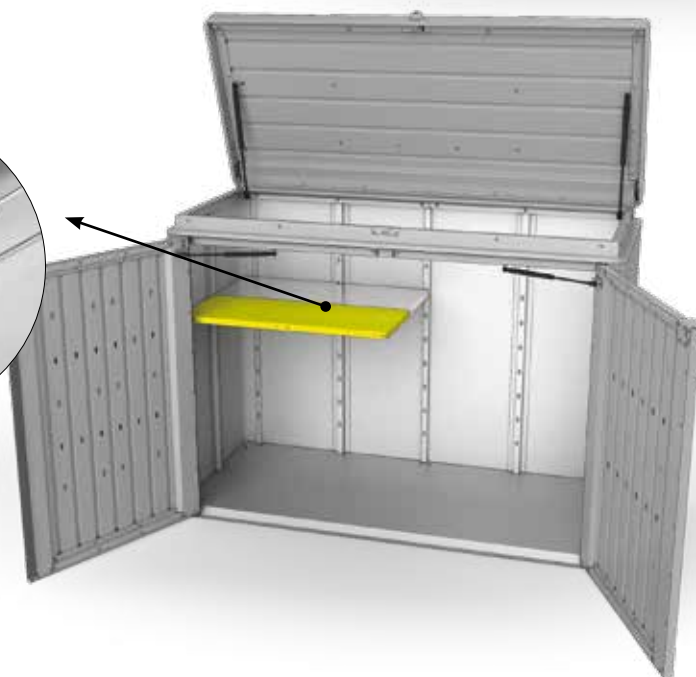
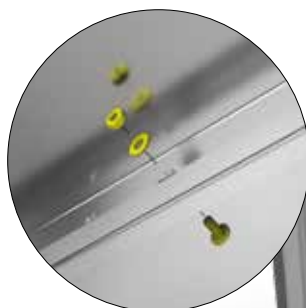



3.

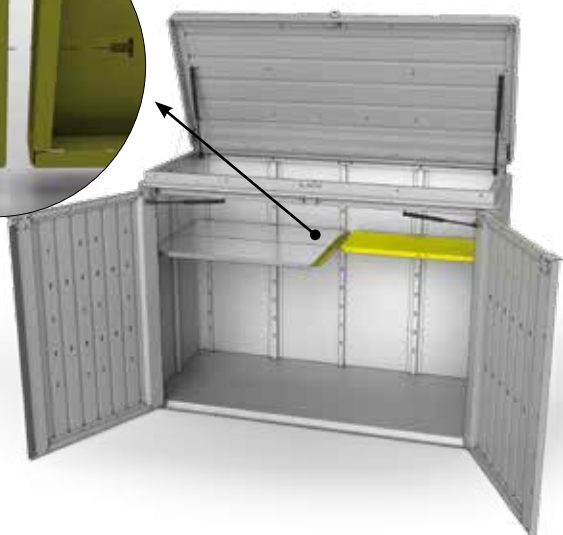
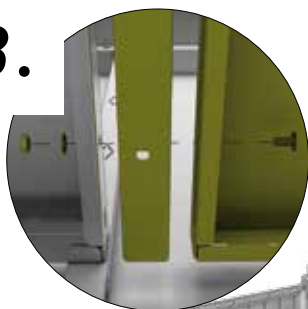

4.



5.

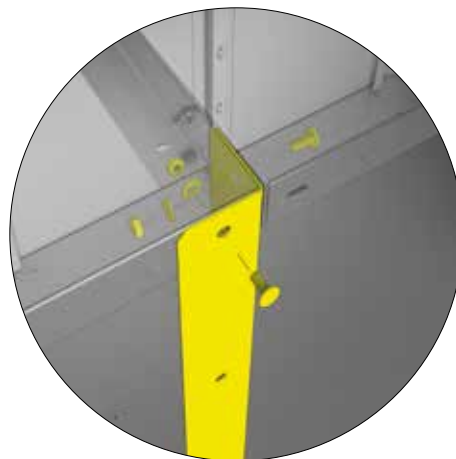

6.

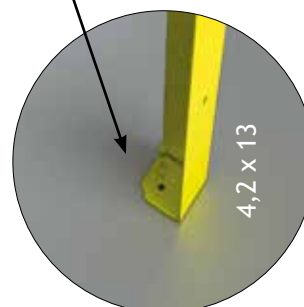
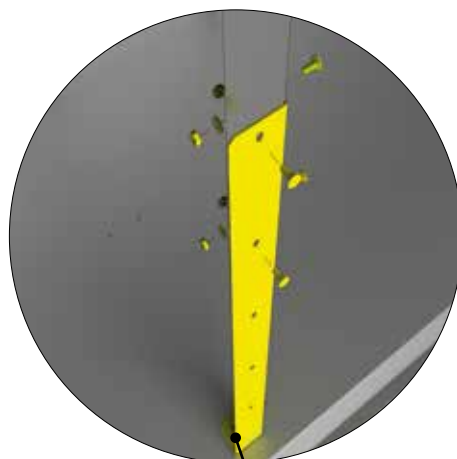
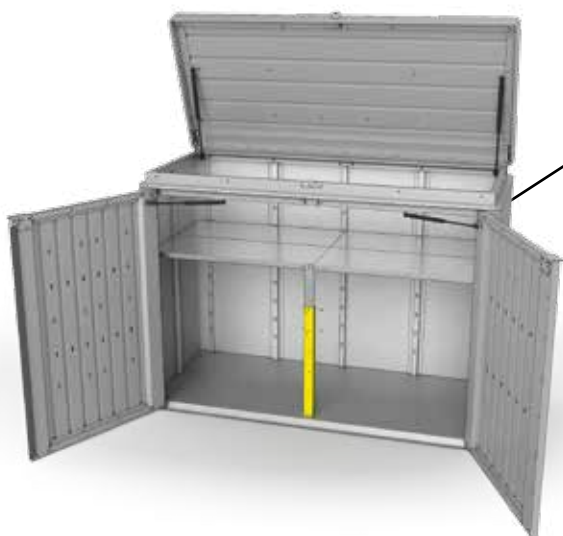



## Zwischenboden Opt. 4

Intermediate floors - Sol intermédiaire - tussenbodem - Ripiano intermedio - Balda intermedia

	4x		1x		1x
M4 x 10 	30x		2x	4,2 x 13 	1x

1.

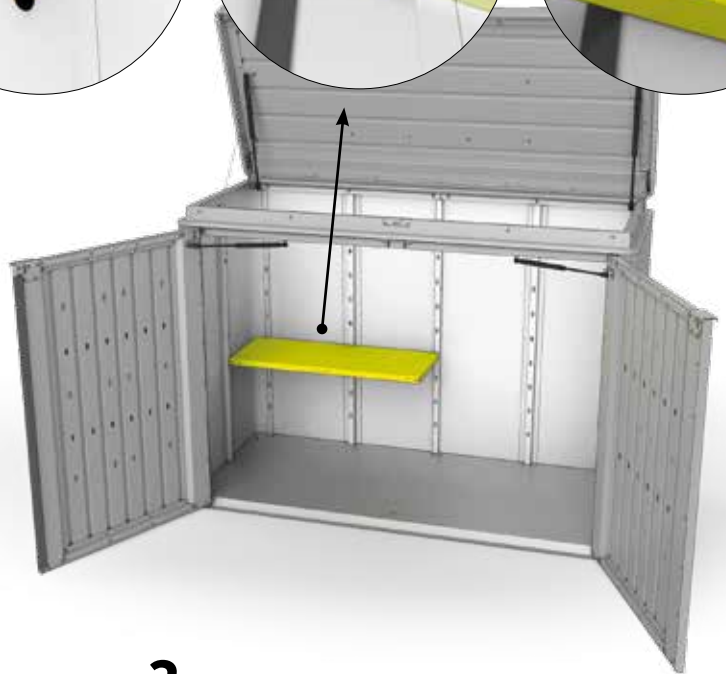
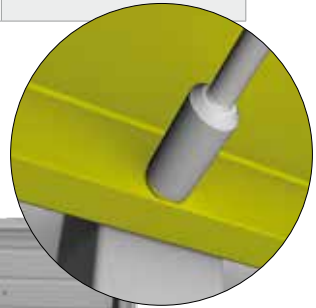
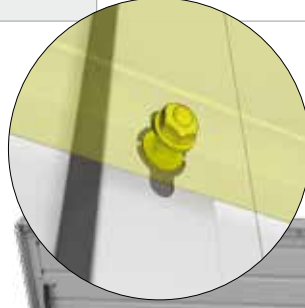
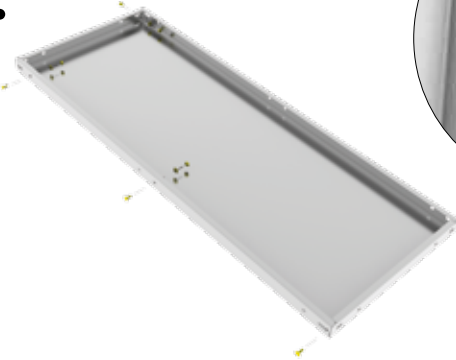

2.

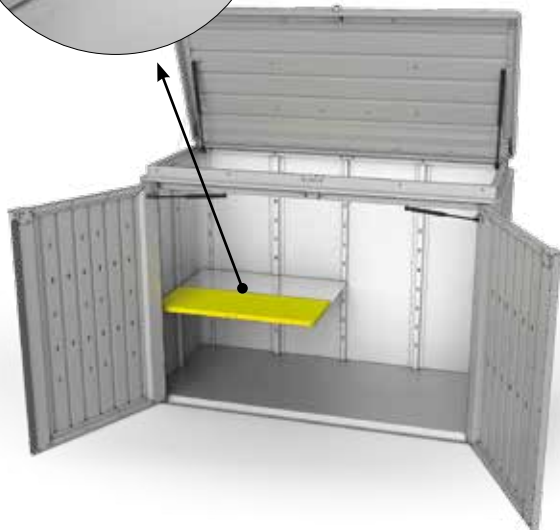
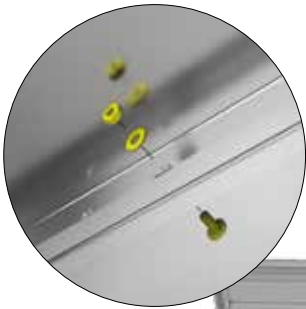

3.



4.



5.

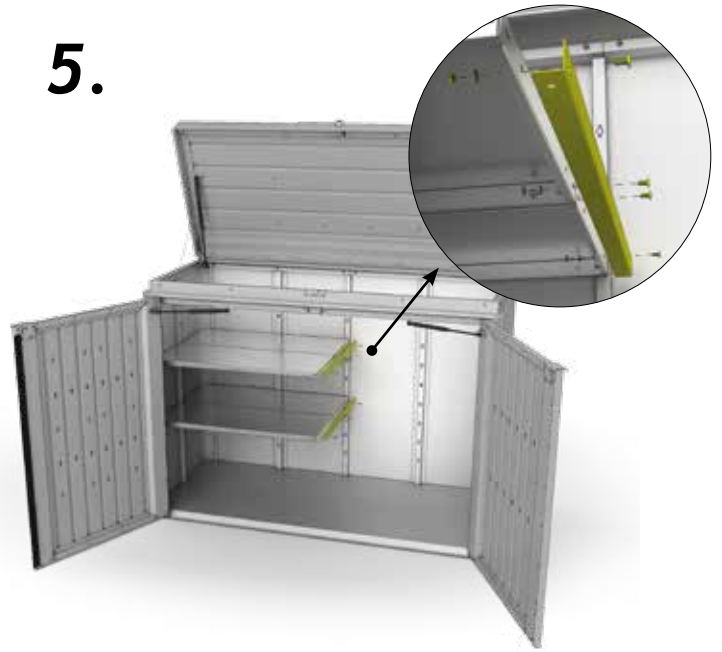

6.

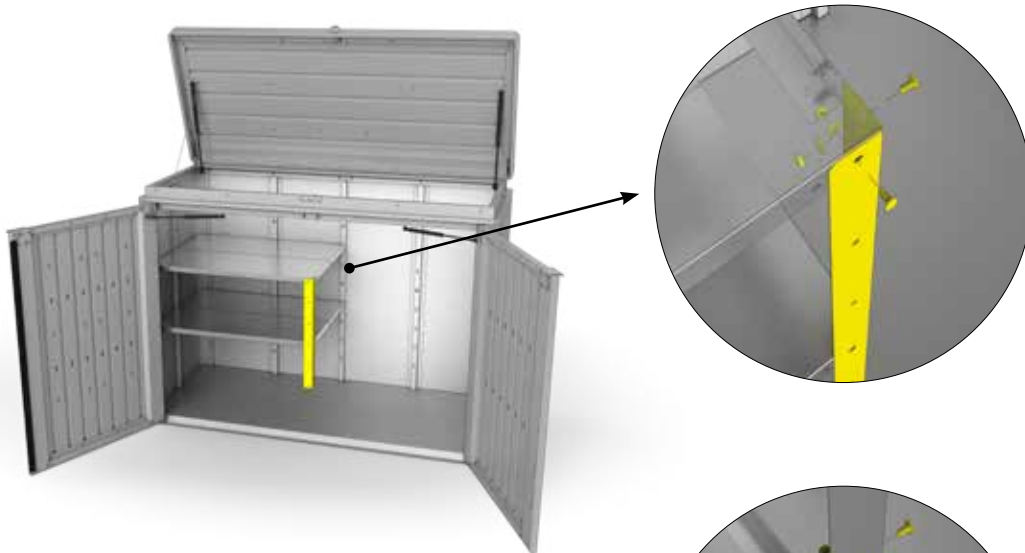

7.

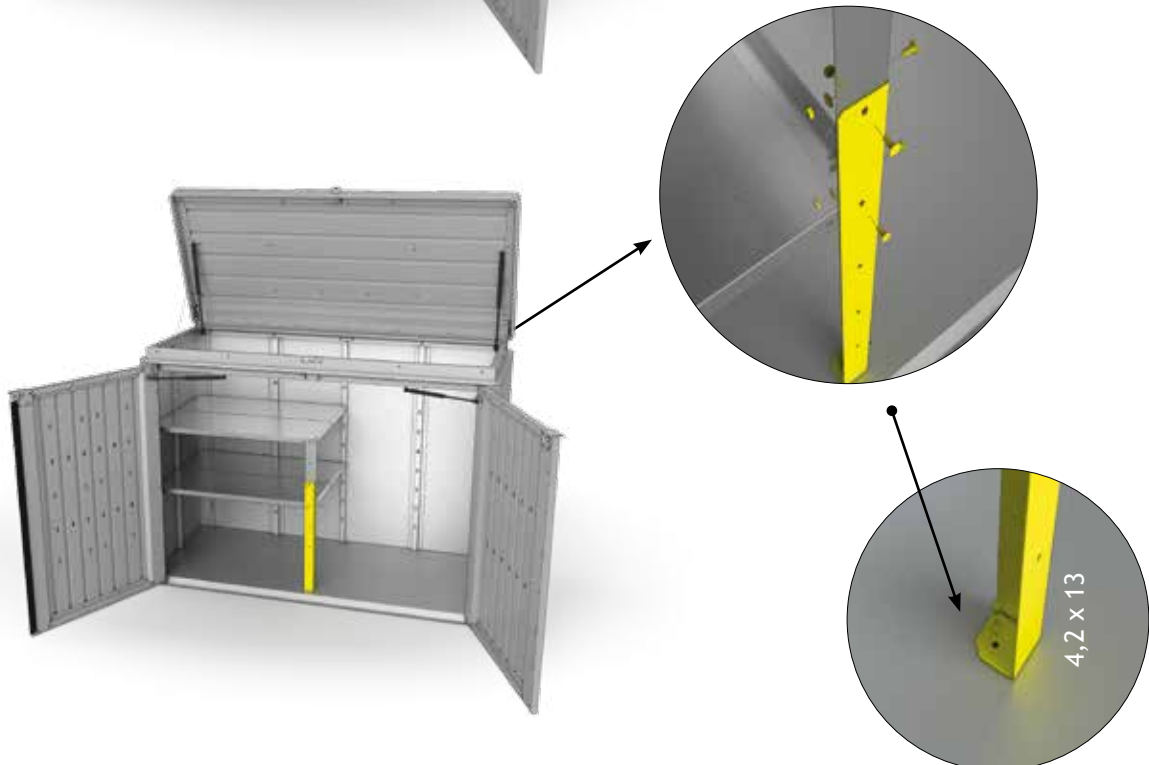



### HighLine®

Das ultimative Gerätehaus, das auch hinsichtlich Sicherheit und Funktionalität alle Anforderungen erfüllt: erhältlich in 5 Größen und in 3 Farben - weiß, silber-metallic, dunkelgrau-metallic



### AvantGarde

Passt bestens zu moderner Architektur und macht lebens-lang Freude: erhältlich in 4 Größen und 3 Farben - silber-metallic, dunkelgrau-metallic, dunkelgrün



### Europa

Alles in bester Ordnung und lebenslange Wartungsfreiheit mit dem Biohort-Klassiker: erhältlich in 9 Größen und 4 Farben - silber-metallic, quarzgrau, dunkelgrau-metallic, dunkelgrün



### Geräteschrank

Wo Raum knapp ist, zeigt er seine Klasse – im Garten, auf der Terrasse, in der Garage: erhältlich in 3 Farben - silber-metallic, dunkelgrau-metallic, dunkelgrün



### WoodStock®

Kaminholzlager und Geräteschrank in einem, auch zum einfachen Wand-Anbau geeignet: erhältlich in 2 Größen und 2 Farben - silber-metallic, dunkelgrau-metallic



### StoreMax®

Mit seinem funktionellen Design bietet der StoreMax® maximalen Stauraum auf wenig Platz: erhältlich in 3 Größen und 3 Farben - silber-metallic, quarzgrau, dunkelgrau-metallic



### HighBoard

Das formvollendete Multitalent zum Aufbewahren: erhältlich in 3 Farben - weiß, silber-metallic, dunkelgrau-metallic



### LoungeBox®

Die Design-Box für gehobene Ansprüche - ein Schmuckstück für Terrasse und Garten: erhältlich in 3 Farben - weiß, silber-metallic, dunkelgrau-metallic



### FreizeitBox

Sie steckt locker all das weg, wofür Sie keinen geeigneten Aufbewahrungsort haben: erhältlich in 4 Größen und 4 Farben - weiß, silber-metallic, dunkelgrau-metallic, dunkelgrün



### Nebengebäude „CasaNova®“

Das erste isolierte Design-Nebengebäude: erhältlich in 9 Größen und 2 Farben - silber-metallic, dunkelgrau-metallic



Qualitätskontrolle:



Biohort GmbH  
Pürnstern 43, 4120 Neufelden, Austria  
Tel.: +43-7282-7788-0, Fax-DW: 190  
E-Mail: office@biohort.at, www.biohort.com

BH-1145-3B-12.14.Bt

