

LAUTERS

10.2 m²



MANUAL DE INSTRUCCIONES · USER'S MANUAL · MANUAL DE INSTRUÇÕES
MANUEL D'INSTRUCTIONS · BENUTZERHANDBUCH · ΕΓΧΕΙΡΙΔΙΟ ΧΡΗΣΤΗ



 **Hoggar**[®]



ÍNDICE

Index - Inhaltsverzeichnis

ES | **Manual de instrucciones**.....04

EN | **User's manual**.....06

PT | **Manual de instruções**.....08

FR | **Manuel d'instructions**10

DE | **Benutzerhandbuch**.....12

**Montaje - Assembly -
Montagem - Montage**14

MANUAL DE INSTRUCCIONES

A nuestros estimados clientes:

Gracias por haber elegido uno de nuestros productos

ANTES DE COMENZAR...



Son necesarias dos personas para el montaje de la caseta



El montaje puede llevar entre 2 y 3 horas



Póngase en contacto con las autoridades para determinar si la instalación está autorizada

Le aconsejamos que siga detenidamente este manual de instrucciones paso por paso para un correcto ensamblado del producto.

Asegúrese que tiene todas las piezas necesarias para su montaje y retire el plástico protector antes de comenzar a montar.

No montar la caseta/armario cerca de niños y/o mascotas.

Planifique la instalación del producto un día seco y sin viento. Evite el montaje en días con clima adverso para evitar daños en el producto o lesiones personales. La caseta no está diseñada para ser construida directamente sobre el césped.

Se recomienda el montaje sobre una base nivelada y firme de madera, un suelo llano de cemento o ladrillos o bloques cementados. Es muy importante fijar la caseta al suelo. No incluye tornillos ni otras piezas necesarias para su anclaje.

Si se hace una plataforma de cemento, es importante que se incline hacia los bordes para evitar la entrada de agua.

Se debe ubicar el producto en un lugar resguardado del viento y con un buen drenaje. Evite colocarlo muy próximo a zonas con árboles, ya que será necesaria una limpieza regular de las ramas y hojas que pudieran caerle.

Recomendamos retirar la nieve de la caseta metálica después de cada nevada.

Nunca debe concentrar el peso del cuerpo en el techo.

Se recomienda para su correcta conservación mantener limpia la caseta con un trapo suave y tener limpio el carril de la puerta para su correcto deslizamiento.

Las casetas están destinadas únicamente a almacenar objetos se prohíbe la residencia u otros efectos.

HERRAMIENTAS NECESARIAS PARA SU MONTAJE

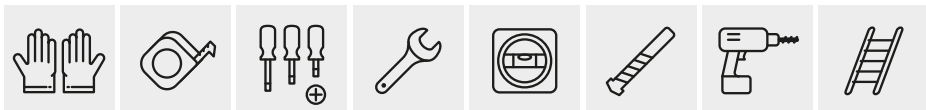

LIMPIEZA Y MANTENIMIENTO

Se recomienda para su correcta conservación mantener limpio el producto, su limpieza se puede hacer con un trapo húmedo suave.

Nunca usar soluciones abrasivas ni detergentes sobre el producto.

Es importante mantener siempre limpios los desagües de la caseta para que no se acumule la suciedad en el tejado.

GARANTÍA

Esta caseta está fabricada con materiales de óptima calidad y bajo estrictos controles y estándares de calidad. En caso de ocurrir algún inconveniente en el producto adquirido, rogamos se ponga en contacto con el servicio de atención al cliente en el teléfono y email que aparecen descritos en la contraportada de este manual de instrucciones.

La garantía es válida a partir de la fecha de compra que aparece en el ticket o factura, el cual deberá presentarse para hacer uso de la garantía.

El periodo de garantía de este producto es de 10 años contra todo inconveniente o fallo consecuencia de un defecto estructural o decoloración.

QUEDAN EXCLUIDAS DE LA GARANTÍA:

- › La no conformidad con el transporte. Hay que comunicárselo a la agencia de transportes en el plazo indicado en el albarán una vez recibido el producto.
- › Las roturas, daños generados por inclemencias meteorológicas como pueden ser fuertes vientos, granizo, riadas etc...
- › El mal montaje, uso incorrecto y consecuencias derivadas de ello.
- › El no mantenimiento y piezas con desgaste como son los amortiguadores, bombín, manilla y bisagras.
- › Las piezas plásticas.
- › La limpieza o mantenimiento con productos abrasivos.
- › Daños por corrosión en piezas o chapas en zonas intermitentes, zonas dañadas de forma indirecta o por estar expuesto a zonas marítimas con salinidad provocando corrosión. Quedan excluidos de garantía daños por corrosión en aristas o esquinas de piezas.
- › La decoloración provocada por el paso del tiempo.
- › Los rayones en la pintura.
- › Los golpes o abollones en la chapa.
- › El no presentar la factura o ticket de venta y la no notificación en plazo y forma.
- › Los costes generados por el tratamiento de piezas defectuosas o dañadas, así como la responsabilidad por daños indirectos que se puedan dar.
- › Uso comercial o con un propósito diferente del personal o doméstico.
- › Modificaciones, pinturas o armado no realizados de conformidad con la ley de garantías y explicaciones del manual de instrucciones, así como los daños causados por exceder la capacidad de carga de almacenamiento del producto.

USER'S MANUAL

Dearest customer:

**Thank you for choosing
one of our products**

BEFORE YOU START YOU SHOULD KNOW...



Two people
are required to
assemble this
shed



Assembly
can take 2-3
hours



Contact the
authorities to
determine if the
installation is
authorized

We advise you to carefully follow this instruction manual step by step for a correct assembly of the product.

Make sure you have all the necessary parts for assembly and remove the protective plastic before starting to assemble.

Do not assemble the shed near children or pets.

Plan to install the product on a dry, windless day. Avoid assembly on adverse weather days to avoid product damage or personal injury. The shed is not designed to be built directly on the lawn.

Mounting on a level, firm base of wood, a flat cement floor, or cemented brick or block is recommended. It is very important to fix the shed to the ground. It does not include screws or other necessary parts for its anchorage.

If a cement base is made, it is important to lean towards the edges to prevent water ingress

The product should be located in a place sheltered from the wind and with good drainage. Avoid placing it very close to areas with trees, since it will be necessary to regularly clean branches and leaves that may fall.

We recommend removing snow from the metal shed after each snowfall.

You should never focus your body weight on the ceiling.

It is recommended for its correct conservation to keep the house clean with a soft cloth and to keep the door track clean for its correct sliding.

The sheds are only intended to store objects, residence or other effects are prohibited.

TOOLS NEEDED FOR ASSEMBLY

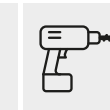
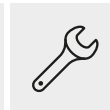

CLEANING AND MAINTENANCE

It is recommended for its correct conservation to keep the product clean, its cleaning can be done with a soft damp cloth.

Never use abrasive solutions or detergents on the product.

It is important to always keep the shed drains clean so that dirt does not accumulate on the roof.

WARRANTY

This shed is made with the highest quality materials and under strict quality controls and standards. In the event of any inconvenience in the purchased product, please contact customer service by phone and email, which are described on the back cover of this instruction manual.

The guarantee is valid from the date of purchase that appears on the ticket or invoice, which must be presented to use the guarantee.

The warranty period for this product is 10 years against any inconvenience or failure resulting from a structural defect or discoloration.

THE WARRANTY IS EXCLUDED:

- › Non conformity with transportation. It must be communicated to the transport agency within the period indicated on the delivery note once the product is received.
- › Breakage, damage caused by inclement weather such as strong winds, hail, floods etc ...
- › The bad assembly, incorrect use and consequences derived from it.
- › Non-maintenance and wear parts such as shock absorbers, cylinder, handle and hinges
- › The plastic pieces.
- › Cleaning or maintenance with abrasive products.
- › Damage due to corrosion in parts or sheets in intermittent areas, indirectly damaged areas or due to being exposed to marine areas with salinity causing corrosion. Damage due to corrosion on parts edges or corners is excluded from the guarantee.
- › Discoloration caused by the passage of time.
- › Scratches in the paint.
- › Knocks or dents in the sheet metal.
- › Failure to present the invoice or sales ticket and failure to notify in due time and form.
- › The costs generated by the treatment of defective or damaged parts, as well as the responsibility for indirect damages that may occur.
- › Commercial use or for a purpose other than personal or domestic.
- › Modifications, paintings or assembly not carried out in accordance with the law of guarantees and explanations of the instruction manual, as well as the damages caused by exceeding the storage capacity of the product.

MANUAL DE INSTRUÇÕES

Aos nossos estimados clientes:

Obrigado por escolher um dos nossos produtos

ANTES DE COMEÇAR, DEVE SABER...



São necessárias duas pessoas para montar o estande



A montagem pode demorar entre 2 e 3 horas



Contactar as autoridades para determinar se a instalação está autorizada

Aconselhamos que siga cuidadosamente este manual de instruções passo a passo para uma montagem correta do produto.

Certifique-se de que tem todas as peças necessárias para a sua montagem.

Planeje a instalação do produto num dia seco e sem vento. Evite montar em dias com condições meteorológicas adversas para evitar danos no produto ou ferimentos pessoais. O abrigo não foi concebido para ser construído diretamente no relvado.

Recomenda-se a montagem numa base de madeira nivelada e firme, num piso plano de cimento ou tijolos ou blocos cimentados. É muito importante fixar o abrigo no chão. Não inclui parafusos ou outras peças necessárias para a fixação.

Se for feita em uma plataforma de betão, é importante que se incline para as bordas para evitar que a água entre no abrigo.

O produto deve estar localizado num local protegido do vento e com boa drenagem. Evite colocá-lo muito perto de áreas com árvores porque então seria necessária uma limpeza regular de ramos e folhas que possam cair.

A montagem deve ser feita pelo menos entre duas pessoas. Mantenha sempre as ferramentas à mão durante a montagem.

FERRAMENTAS NECESSÁRIAS



LIMPEZA E MANUTENÇÃO

Recomenda-se para uma conservação adequada manter o produto limpo, a sua limpeza pode ser feita com um pano húmido suave.

Nunca utilize soluções abrasivas ou detergentes no produto.

É importante manter sempre os esgotos limpos para que a sujidade não se acumule no telhado.

GARANTIA

Esta casa é feita com materiais da mais alta qualidade e sob rigorosos controles e padrões de qualidade. No caso de qualquer inconveniente no produto adquirido, entre em contato com o atendimento ao cliente por telefone e e-mail, descritos na contracapa deste manual de instruções.

A garantia é válida a partir da data da compra que aparece no bilhete ou na fatura, que deve ser apresentada para o uso da garantia.

O período de garantia deste produto é de 10 anos contra qualquer inconveniente ou falha resultante de um defeito estrutural ou descoloração.

A GARANTIA É EXCLUÍDA:

- › Não conformidade com transporte. Ele deve ser comunicado à agência de transporte dentro do prazo indicado na nota de entrega assim que o produto for recebido.
- › Ruptura, danos causados por intempéries, como ventos fortes, granizo, inundações etc..
- › A má montagem, o uso incorreto e as consequências dela derivadas.
- › Peças que não são de manutenção e de desgaste, como amortecedores, cilindro, manopla e dobradiças.
- › As peças de plástico.
- › Limpeza ou manutenção com produtos abrasivos.
- › Danos devido à corrosão de peças ou chapas em áreas intermitentes, áreas indiretamente danificadas ou devido à exposição a áreas marinhas com salinidade, causando corrosão. Danos devido à corrosão nas bordas ou cantos das peças estão excluídos da garantia.
- › Descoloração causada pela passagem do tempo.
- › Arranhões na tinta.
- › Batidas ou amolgadelas na chapa.
- › Falha na apresentação da fatura ou ticket de venda e falha na notificação no devido tempo e formulário.
- › Os custos gerados pelo tratamento de peças defeituosas ou danificadas, bem como a responsabilidade por danos indiretos que possam ocorrer.
- › Uso comercial ou para outros fins que não pessoais ou domésticos.
- › Modificações, pinturas ou montagens não realizadas de acordo com a lei de garantias e explicações do manual de instruções, bem como os danos causados por exceder a capacidade de armazenamento do produto.

MANUEL D'INSTRUCTIONS

À nos chers clients:

**Merci d'avoir choisi l'un
de nos produits**

AVANT DE COMMENCER...



Deux personnes
sont nécessaires
pour assembler
l'abri



Le montage
peut
prendre 2 à
3 heures



Contactez les
autorités pour
déterminer si
l'installation est
autorisée

Nous vous conseillons de suivre attentivement ce mode d'emploi étape par étape pour un montage correct du produit.

Assurez-vous que vous disposez de toutes les pièces nécessaires pour le montage et retirez le plastique de protection avant de commencer l'assemblage.

Ne montez pas l'abri/ le placard près des enfants et / ou des animaux domestiques.

Prévoyez d'installer le produit en temps sec et sans vent. Évitez le montage les jours de mauvais temps pour éviter d'endommager le produit ou de vous blesser. L'abri n'est pas conçu pour être construit directement sur la pelouse.

Il est recommandé de monter sur une base de bois ferme et de niveau, sur un sol en ciment plat ou sur de la brique ou du bloc de ciment. Il est très important de fixer l'abri au sol. Il ne comprend pas de vis ou d'autres pièces nécessaires à son ancrage.

Si une terrasse en ciment est fabriquée, il est important de se pencher vers les bords pour éviter la pénétration d'eau.

Le produit doit être situé dans un endroit à l'abri du vent et avec un bon drainage. Évitez de le placer très près des zones arborées, car il sera nécessaire de nettoyer régulièrement les branches et les feuilles qui pourraient tomber.

Nous vous recommandons de retirer la neige du hangar métallique après chaque chute de neige.

Vous ne devez jamais concentrer votre poids corporel sur le plafond.

Pour sa bonne conservation, il est recommandé de garder l'abri propre avec un chiffon doux et de garder le rail de porte propre pour un bon coulissement.

Les abris sont uniquement destinées à stocker des objets, la résidence ou tout autre effet est interdit.

OUTILS NÉCESSAIRES POUR L'ASSEMBLAGE



NETTOYAGE ET ENTRETIEN

Il est recommandé pour sa bonne conservation de garder le produit propre, son nettoyage peut se faire avec un chiffon doux et humide.

N'utilisez jamais de solutions abrasives ou de détergents sur le produit.

Il est important de toujours garder les drains de l'abri propres afin que la saleté ne s'accumule pas sur le toit.



GARANTIE

Cet abri est fait de matériaux de la plus haute qualité et sous des contrôles et des normes de qualité stricts. En cas de désagrément dans le produit acheté, veuillez contacter le service client par téléphone et par e-mail, qui sont décrits au dos de ce manuel d'instructions.

La garantie est valable à partir de la date d'achat qui apparaît sur le billet ou la facture, qui doit être présentée pour faire usage de la garantie.

La période de garantie de ce produit est de 10 ans contre tout inconvénient ou défaillance résultant d'un défaut structurel ou d'une décoloration.

LA GARANTIE EST EXCLUE:

- › Non-conformité avec le transport. Il doit être communiqué à l'agence de transport dans le délai indiqué sur le bon de livraison une fois le produit reçu.
- › Casses, dommages causés par des intempéries telles que vents forts, grêle, inondations, etc.
- › Le mauvais assemblage, une mauvaise utilisation et les conséquences qui en découlent.
- › Pièces sans entretien et d'usure telles que les amortisseurs, le cylindre, la poignée et les charnières.
- › Les pièces en plastique.
- › Nettoyage ou entretien avec des produits abrasifs.
- › Dommages dus à la corrosion de pièces ou de tôles dans des zones intermittentes, des zones indirectement endommagées ou dus à une exposition à des zones marines dont la salinité provoque la corrosion. Les dommages dus à la corrosion sur les bords ou les coins des pièces sont exclus de la garantie.
- › Décoloration causée par le passage du temps.
- › Rayures dans la peinture.
- › Coups ou bosses dans la tôle.
- › Défaut de présenter la facture ou le ticket de vente et défaut de notification en temps et en forme.
- › Les coûts engendrés par le traitement des pièces défectueuses ou endommagées, ainsi que la responsabilité des dommages indirects qui pourraient survenir.
- › Utilisation commerciale ou à des fins autres que personnelles ou domestiques.
- › Modifications, peintures ou assemblages non effectués conformément à la loi des garanties et explications du mode d'emploi, ainsi que les dommages causés par le dépassement de la capacité de stockage du produit.

BENUTZERHANDBUCH

An unsere lieben Kunden:

**Vielen Dank für Ihre Wahl
eines unserer Produkte**

BEVOR SIE ANFANGEN...



Für die Montage
sind zwei
Personen
erforderlich



Die Montage
kann 2-3
Stunden
dauern



Wenden Sie sich
an die Behörden,
um festzustellen,
ob die Installation
autorisiert ist

Wir empfehlen Ihnen, diese Bedienungsanleitung Schritt für Schritt sorgfältig zu befolgen, um eine korrekte Montage des Produkts zu gewährleisten.

Stellen Sie sicher, dass Sie alle für die Montage erforderlichen Teile haben, und entfernen Sie die Plastikfolie bevor Sie beginnen.

Montieren Sie das Gerätehaus / den Schrank nicht in der Nähe von Kindern und / oder Haustieren.

Planen Sie die Installation des Produkts an einem trockenen, windstillen Tag. Vermeiden Sie die Montage an Tagen mit widrigem Wetter um Produktschäden oder Verletzungen zu vermeiden. Das Gerätehaus ist nicht dafür ausgelegt, direkt auf dem Rasen aufgebaut zu werden.

Es wird empfohlen, auf einer ebenen, festen Holzbasis, einem flachen Zementboden oder einem zementierten Ziegel oder Block zu montieren. Es ist sehr wichtig, das Haus am Boden zu befestigen. Schrauben oder andere notwendige Teile für die Verankerung sind nicht enthalten.

Wenn ein Zementboden verwendet wird, ist es wichtig, die erforderliche Neigung zu berücksichtigen, um das Eindringen von Wasser zu verhindern

Das Produkt sollte an einem windgeschützten Ort mit guter Drainage aufgestellt werden. Stellen Sie es nicht in der Nähe von Bäumen auf, da regelmäßig herunterfallende Zweige und Blätter gereinigt werden müssen.

Wir empfehlen, nach jedem Schneefall den Schnee von dem Gerätehaus zu entfernen.

Sie sollten Ihr Körpergewicht niemals auf die Decke konzentrieren.

Für die korrekte Konservierung wird empfohlen, das Gerätehaus mit einem weichen Tuch sauber zu halten und die Türschiene für das korrekte Gleiten sauber zu halten.

Die Gerätehäuser sind nur zur Aufbewahrung von Gegenständen gedacht, Wohnsitz oder andere Gebrauche sind verboten.

ERFORDERLICHE WERKZEUGE FÜR DIE MONTAGE



REINIGUNG UND INSTANDHALTUNG

Es wird für die korrekte Konservierung empfohlen, das Produkt sauber zu halten. Die Reinigung kann mit einem weichen, feuchten Tuch erfolgen.

Verwenden Sie niemals Schleiflösungen oder Reinigungsmittel für das Produkt.

Es ist wichtig, die Entwässerungen immer sauber zu halten, damit sich kein Schmutz auf dem Dach ansammelt.

GARANTIE

Dieses Gerätehaus besteht aus Materialien höchster Qualität und unterliegt strengen Qualitätskontrollen und Standards. Im Falle von Unannehmlichkeiten mit dem gekauften Produkt wenden Sie sich bitte telefonisch und per E-Mail an den Kundendienst, wie auf der Rückseite dieser Bedienungsanleitung beschrieben.





















Die Garantie gilt ab dem Kaufdatum, das auf dem Ticket oder der Rechnung angegeben ist und vorgelegt werden muss, um die Garantie nutzen zu können.





















Die Garantiezeit für dieses Produkt beträgt 10 Jahre gegen Unannehmlichkeiten oder Ausfälle aufgrund eines strukturellen Defekts oder einer Verfärbung.











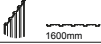
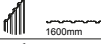
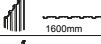





VON DER GARANTIE AUSGESCHLOSSEN SIND:



- › Nichtübereinstimmung mit dem Transport. Sie müssen das Transportunternehmen innerhalb der auf dem Lieferschein angegebenen Zeit benachrichtigen, sobald das Produkt eingegangen ist.
- › Bruch, Schäden durch schlechtes Wetter wie starker Wind, Hagel, Überschwemmungen usw.
- › Die schlechte Montage, falsche Verwendung und die daraus resultierenden Konsequenzen.
- › Wartungs- und Verschleißteile wie Stoßdämpfer, Zylinder, Griff und Scharniere.
- › Kunststoffteile.
- › Reinigung oder Wartung mit Schleifmitteln.
- › Korrosionsschäden an Teilen oder Blechen in intermittierenden Bereichen, indirekt beschädigten Bereichen oder in Meeresgebieten mit Salzgehalt, die Korrosion verursachen.
- › Schäden durch Korrosion an Teilekanten oder -ecken sind von der Garantie ausgeschlossen.
- › Verfärbung im Laufe der Zeit.
- › Kratzer in der Farbe.
- › Schläge oder Dellen im Blech.
- › Nichtvorlage der Rechnung oder des Verkaufstickets und Nicht fristgerechte Benachrichtigung.
- › Die Kosten, die durch die Behandlung defekter oder beschädigter Teile entstehen, sowie die Verantwortung für indirekte Schäden, die auftreten können.
- › Kommerzielle Nutzung oder für einen anderen als den persönlichen oder häuslichen Zweck.
- › Änderungen, Anstriche oder Montagen, die nicht gemäß dem Gesetz über Garantien und Erläuterungen in der Bedienungsanleitung durchgeführt wurden, sowie Schäden, die durch Überschreitung der Lagerkapazität des Produkts verursacht wurden.

MONTAJE · Assembly · montagem · montage

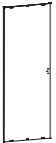

NO.	PART	Qty.
1L	 1597mm	2
1R	 1597mm	2
2L	 1597mm	1
2R	 1597mm	1
3L	 1023mm	1
3R	 1023mm	1
4L	 1600mm	1
4R	 1600mm	1
5	 1246mm	1
6	 1304mm	1
7	 1533mm	1
8	 1533mm	1
9	 1543mm	2
11	 1543mm	2
10L	 1546mm	1
10R	 1546mm	1
12	 356mm	2
13	 1601mm	2
14	 1601mm	2
15	 1304mm	2

NO.	PART	Qty.
16	 1672mm	1
16-1	 1672mm	1
17L	 1651mm	2
17R	 1651mm	2
18	 655mm	6
19	 1304mm	2
20	 662mm	1
21L	 2	2
21R	 2	2
22L	 1546mm	2
22R	 1546mm	2
23L	 1546mm	1
23R	 1546mm	1
B1	 197mm	2
B2	 197mm	2
B3	 400mm	2
B4	 400mm	2
15-1	 1304mm	1
15-2	 1304mm	1
24-1	 662mm	1
24-2	 662mm	1

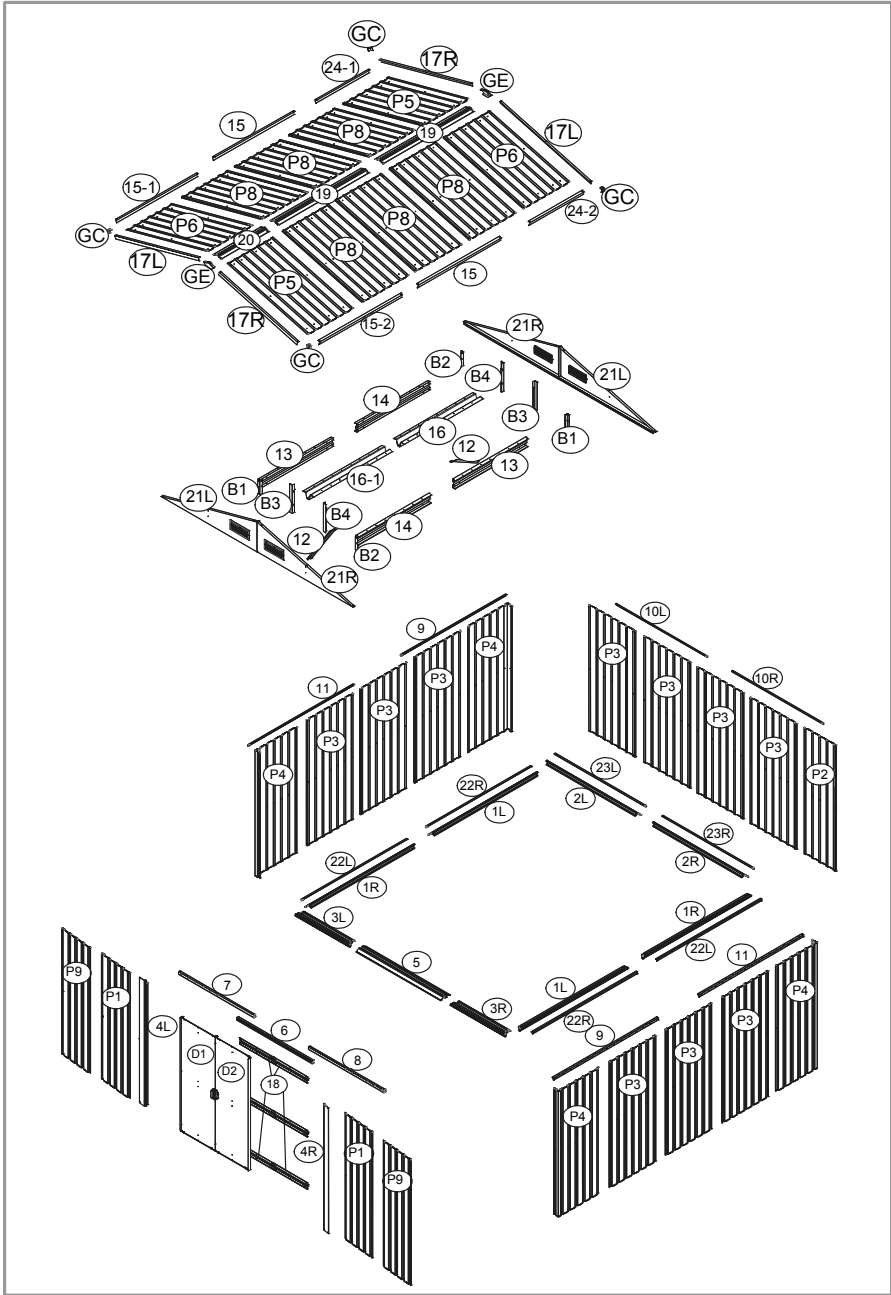

NO.	PART	Qty.
P1	 1600mm	2
P2	 1600mm	1
P3	 1600mm	10
P4	 1600mm	4
P9	 1600mm	2
P5	 1650mm	2
P6	 1650mm	2
P8	 1650mm	6
G2	 4	4
GD	 4	4
GF	 4	4
GB	 2	2
GC	 4	4
GE	 2	2
F1	 460	460
F2	 80	80
F3	 8	8
S2	 330	330
S3	 444	444

NO.	PART	Qty.
D1	 1590X659mm	1
D2	 1590X659mm	1

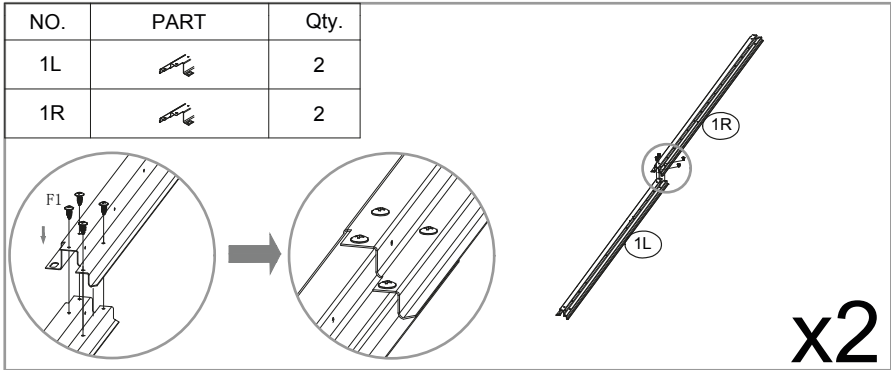

NO.	PART	Qty.
1L		2
1R		2



NO.	PART	Qty.
2L		1
2R		1

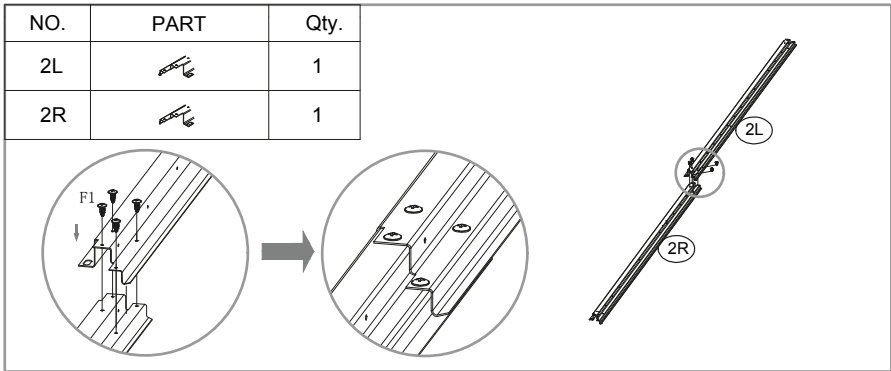
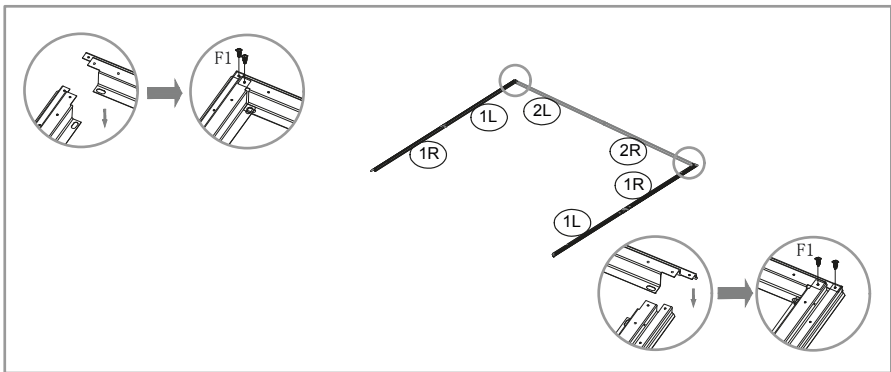

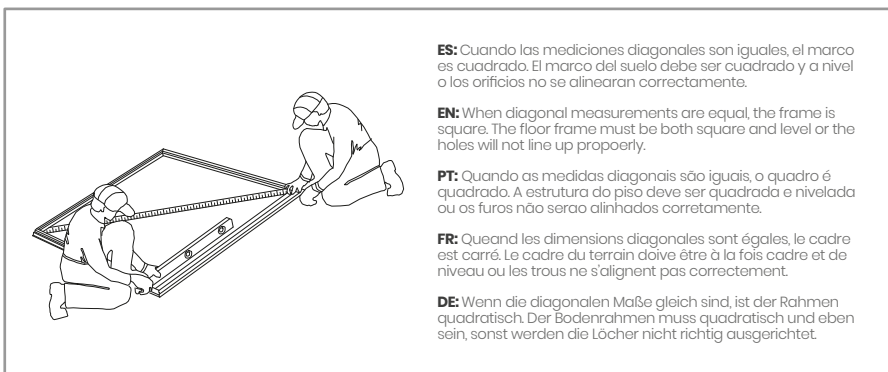
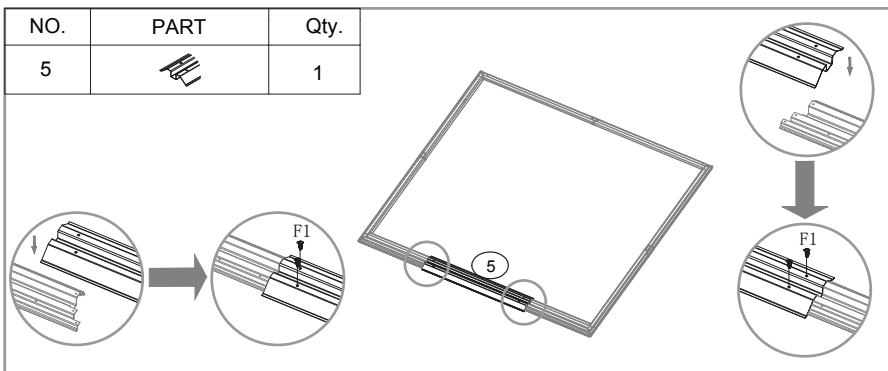
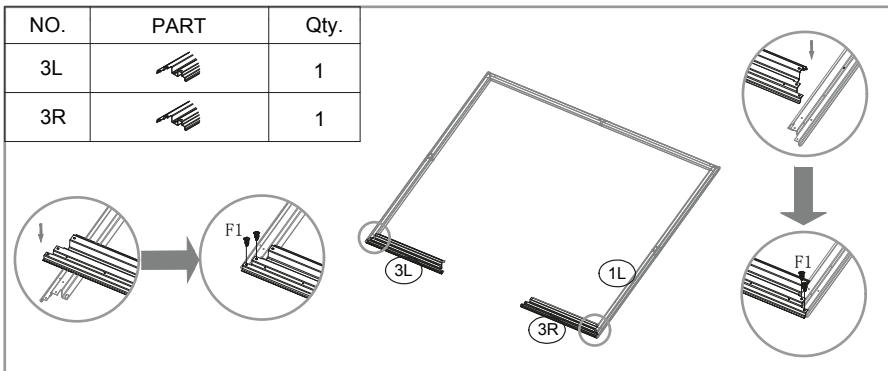

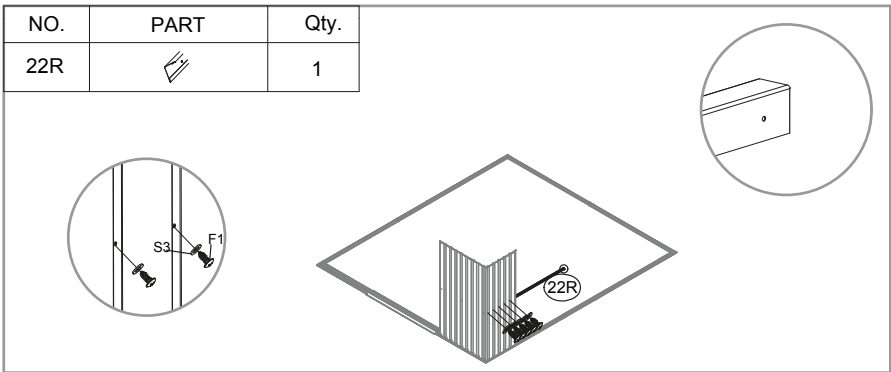
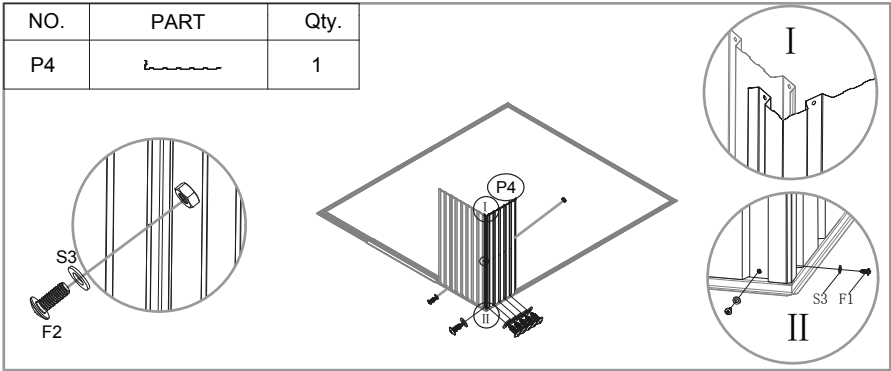
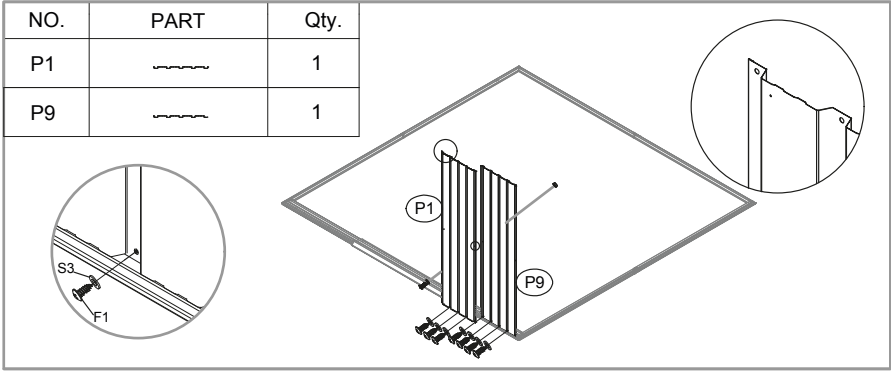

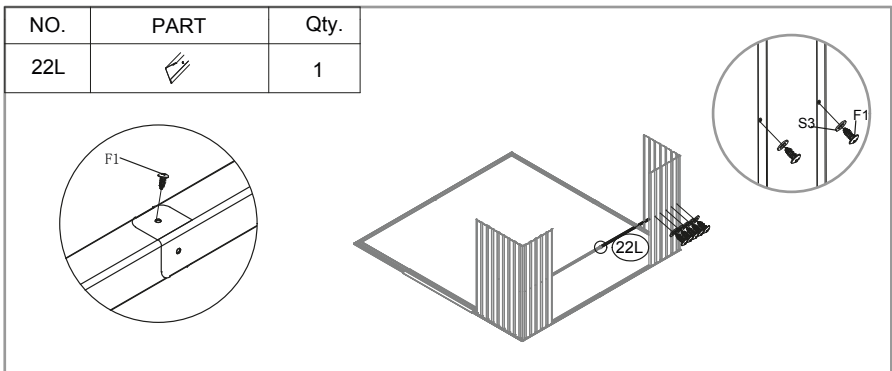
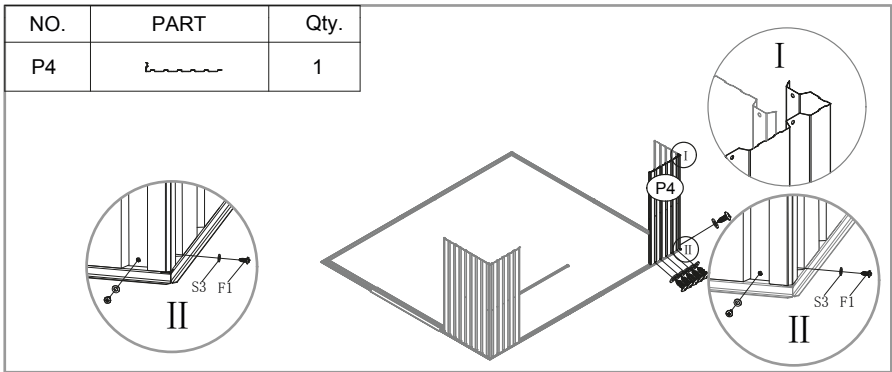
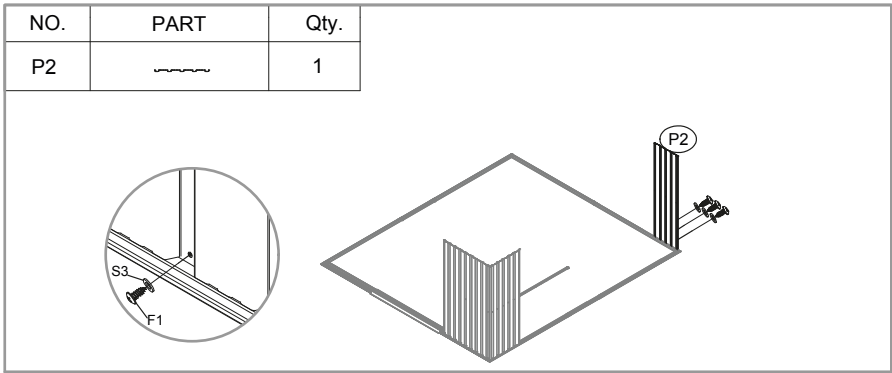

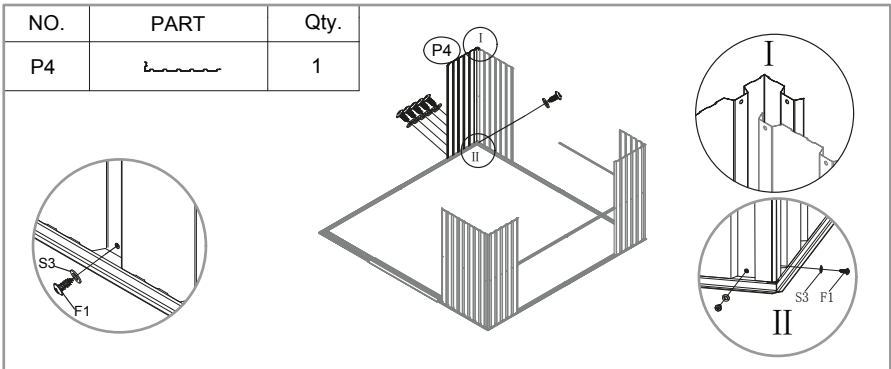
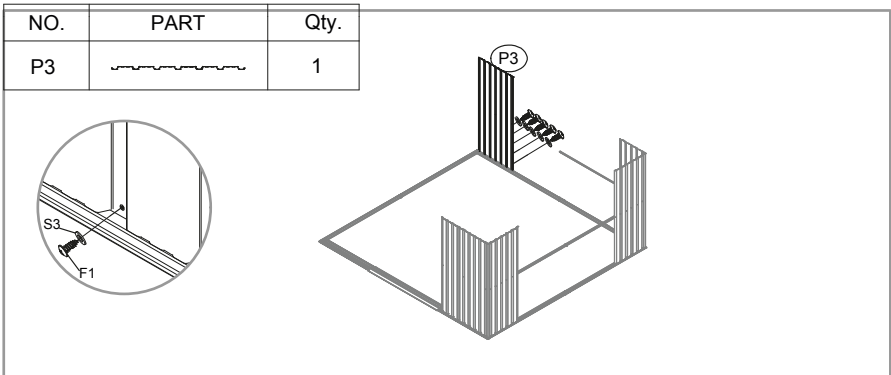
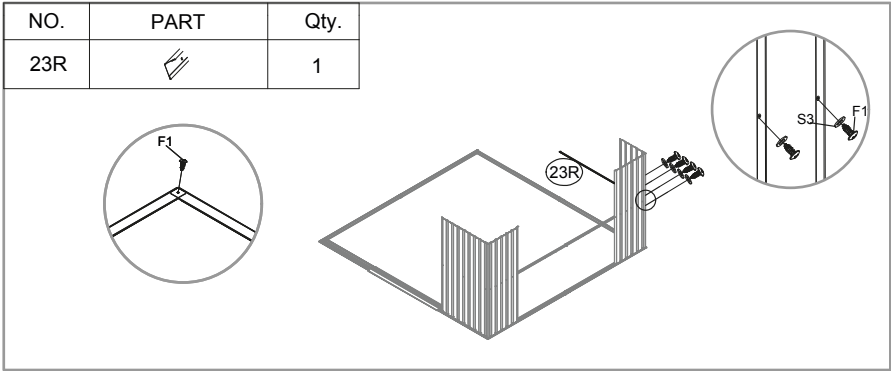

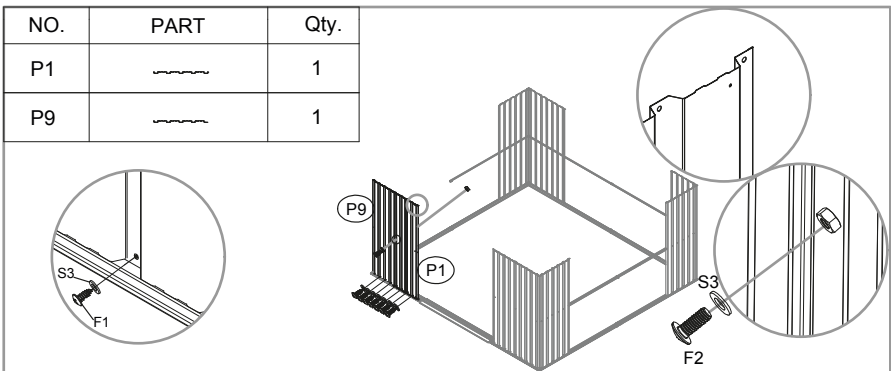
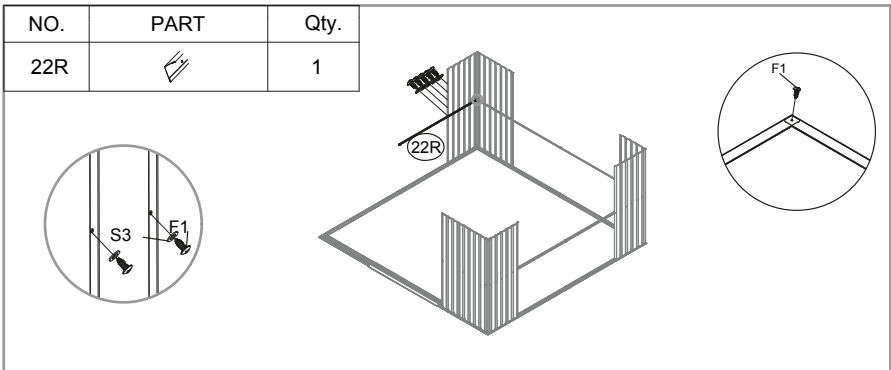
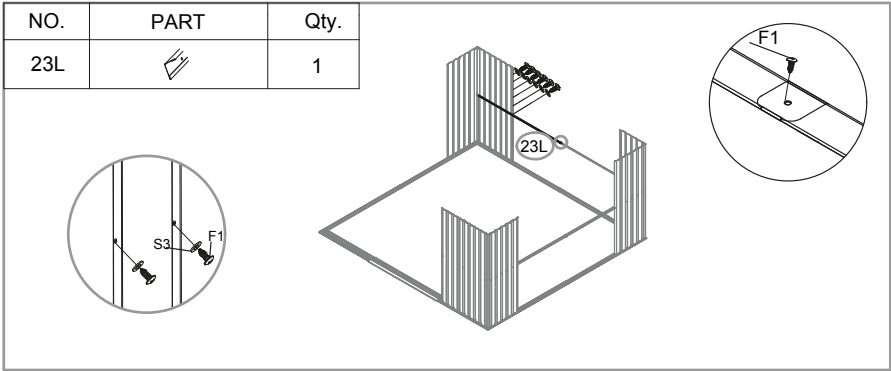



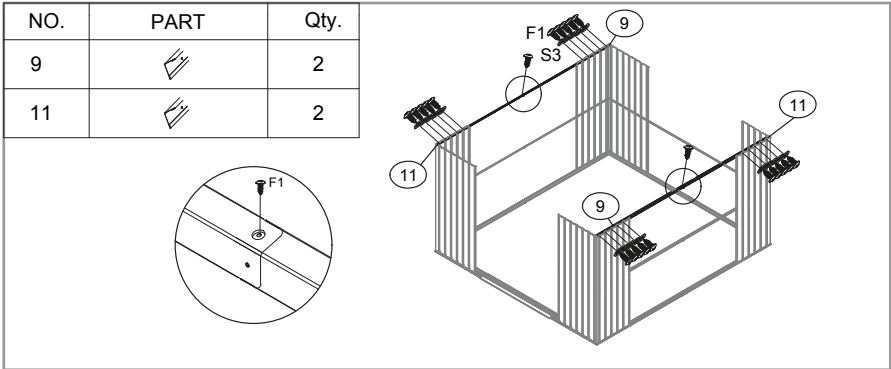
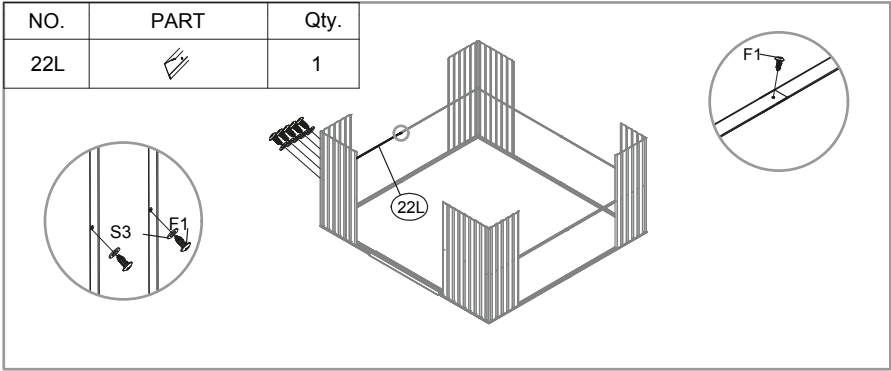
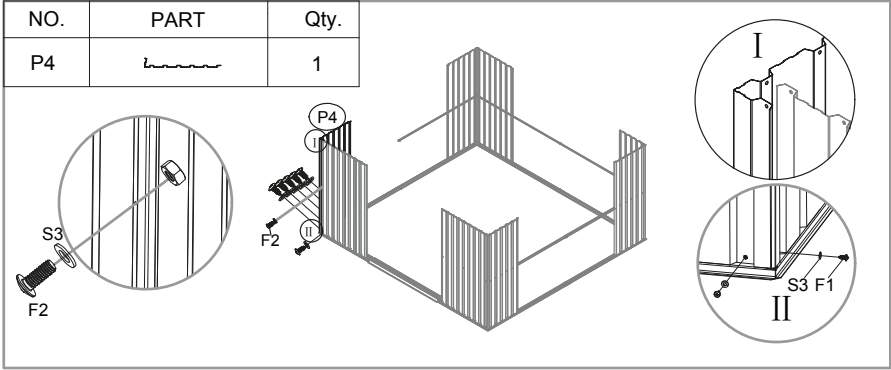

NO.	PART	Qty.	NO.	PART	Qty.
21L		2	B3		2
21R		2	B4		2
B1		2	12		2
B2		2			

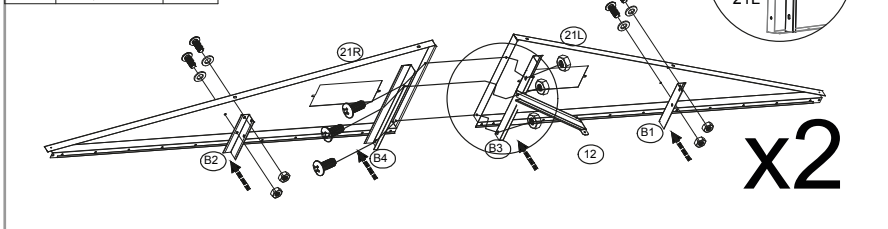

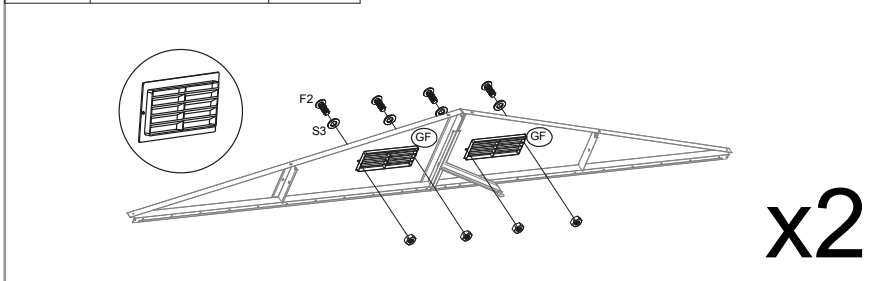

NO.	PART	Qty.
GF		4

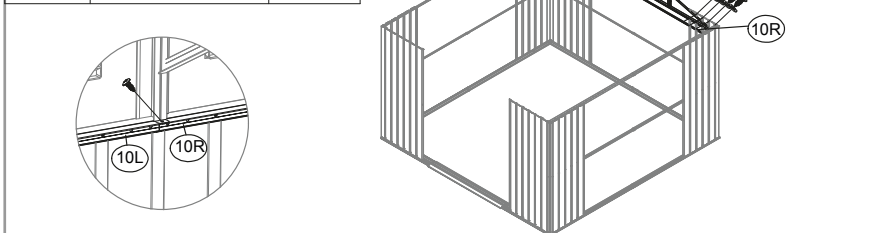

NO.	PART	Qty.
10L		1
10R		1



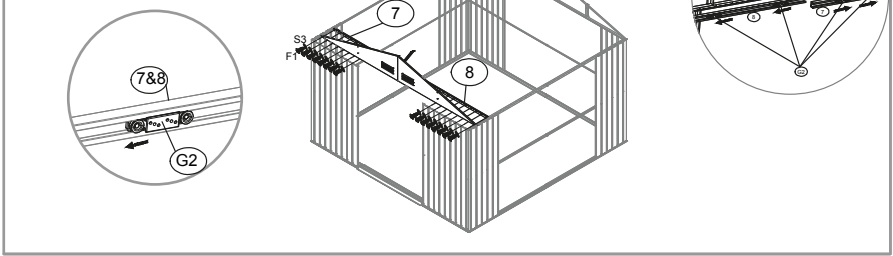

NO.	PART	Qty.
7		1
8		1
G2		4

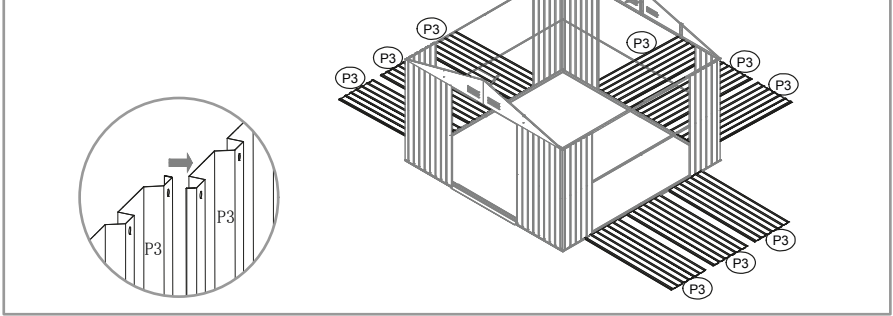

NO.	PART	Qty.
P3		9



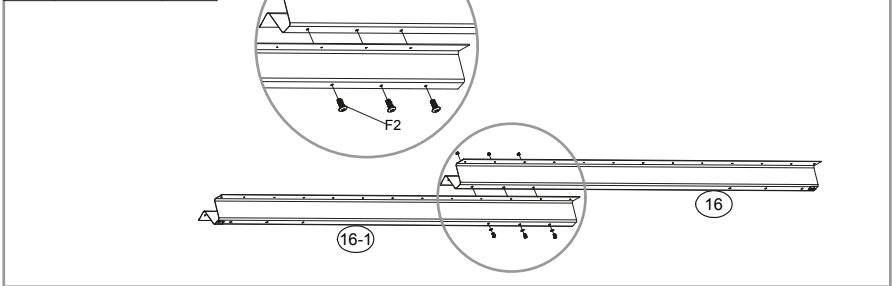

NO.	PART	Qty.
16		1
16-1		1

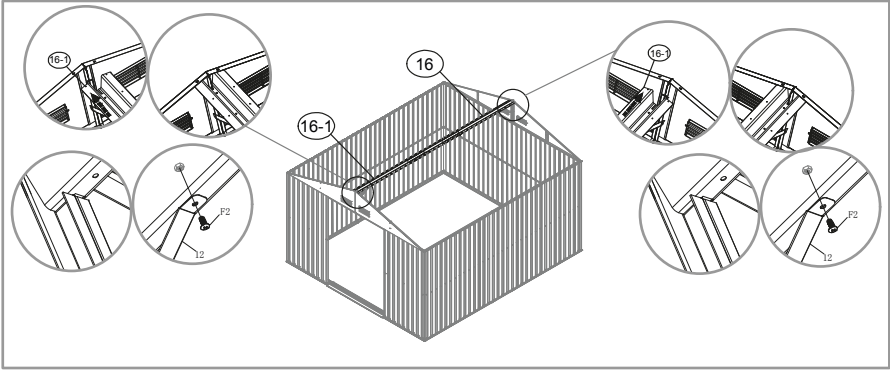



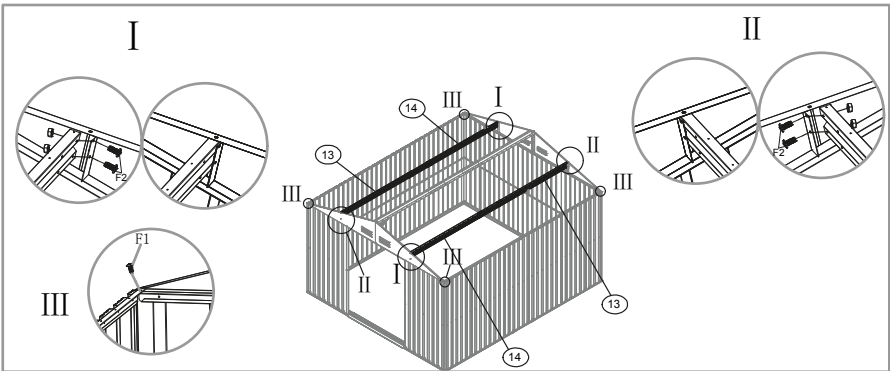
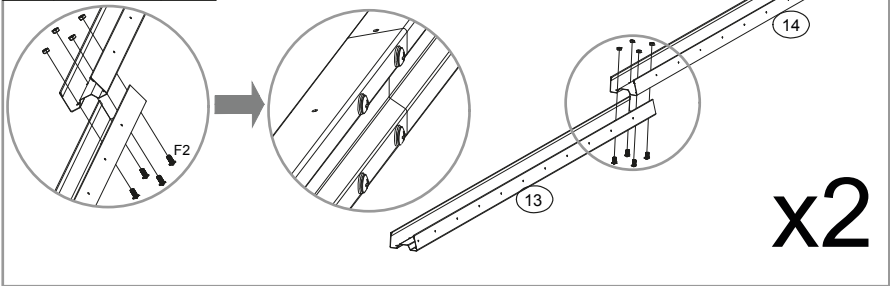

NO.	PART	Qty.
13		2
14		2

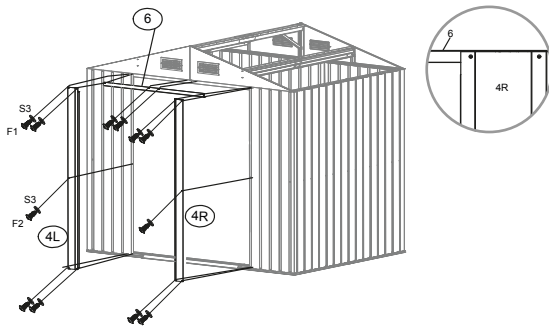

NO.	PART	Qty.
4L		1
4R		1
6		1



NO.	PART	Qty.
P5		1
P6		1

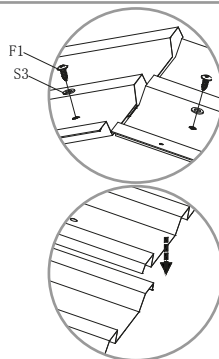
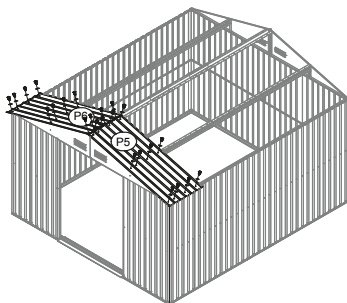

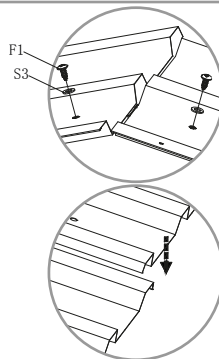
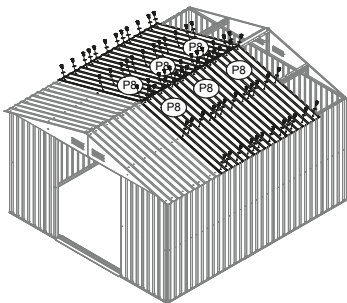

NO.	PART	Qty.
P8		6

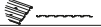
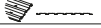

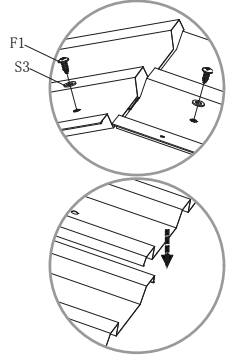
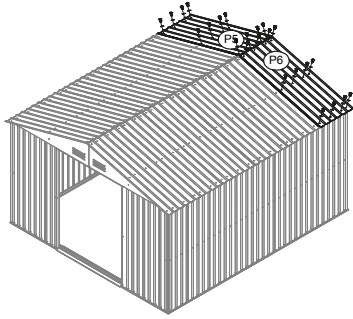

NO.	PART	Qty.
P5		1
P6		1



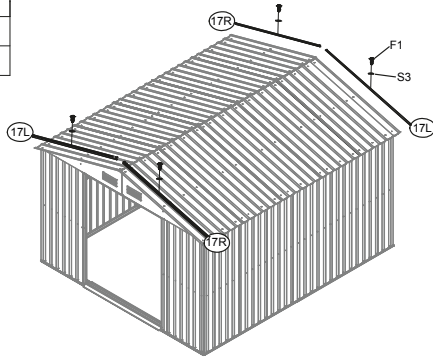



NO.	PART	Qty.
17L		2
17R		2

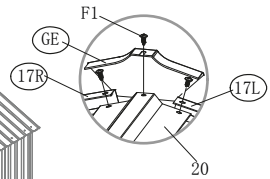
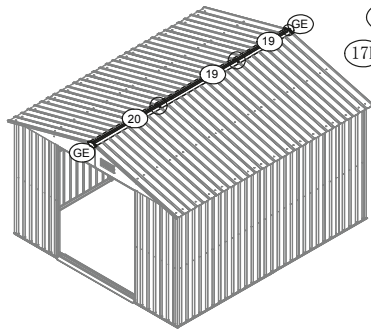
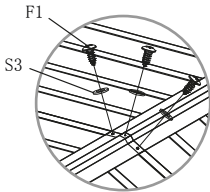



NO.	PART	Qty.
19		2
20		1
GE		2

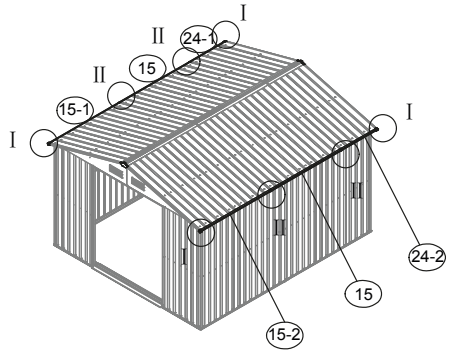
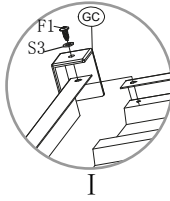
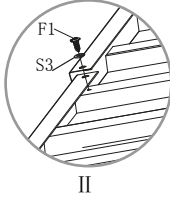

NO.	PART	Qty.
15		2
15-1&15-2		1
24-1&24-2		1
GC		4



NO.	PART	Qty.
D1		1
D2		1
GB		2

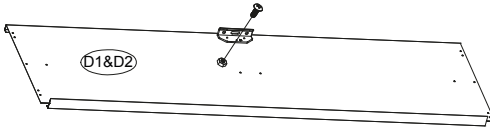
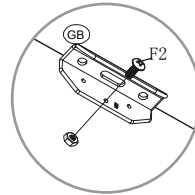

x2

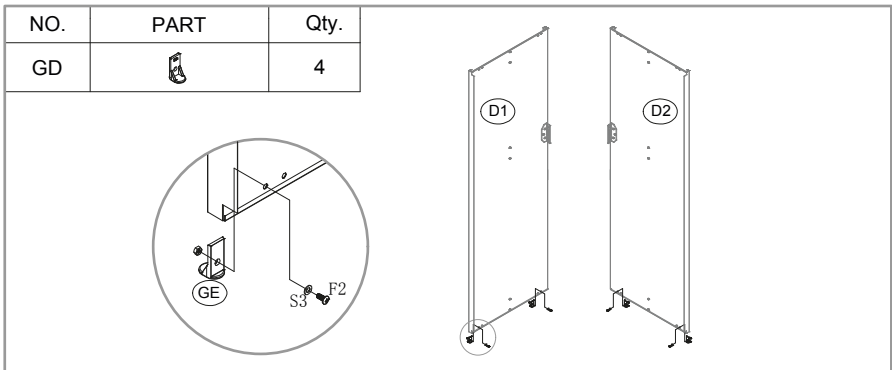
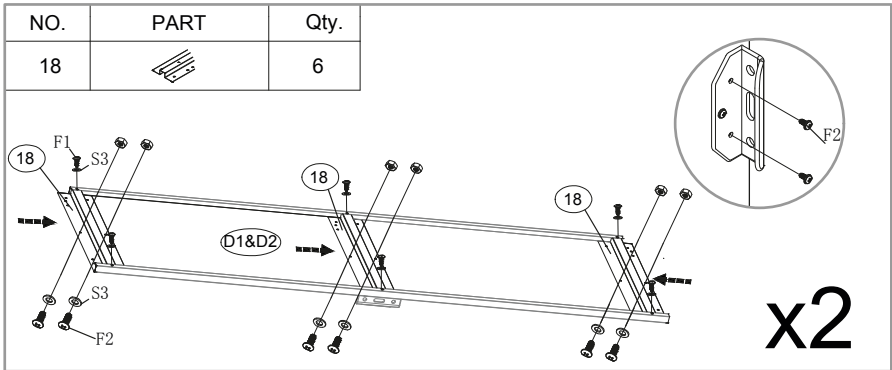

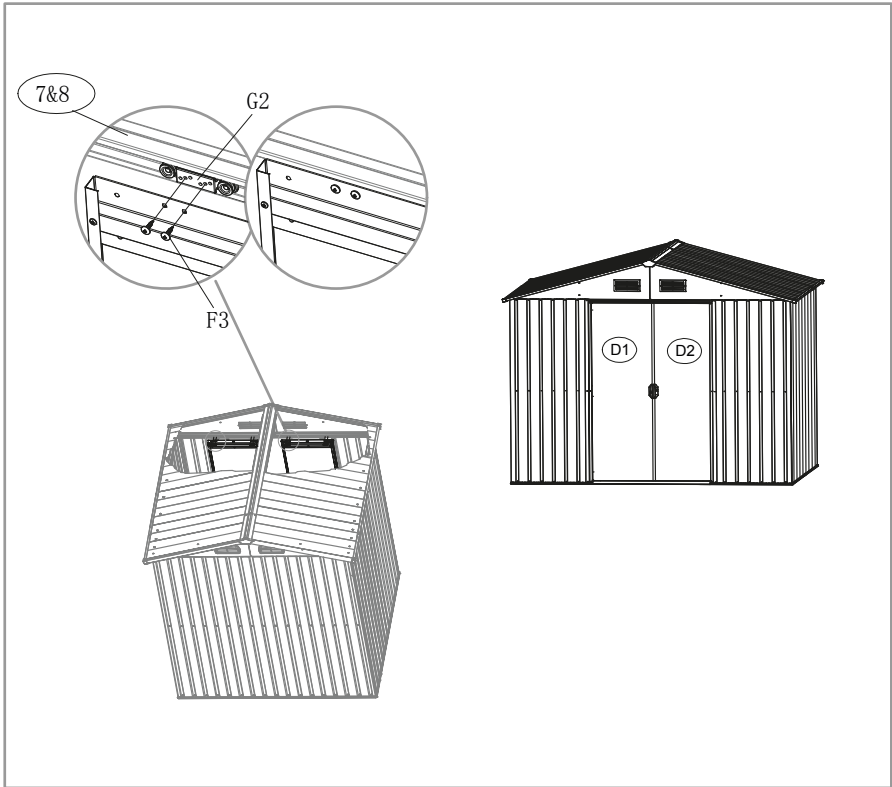

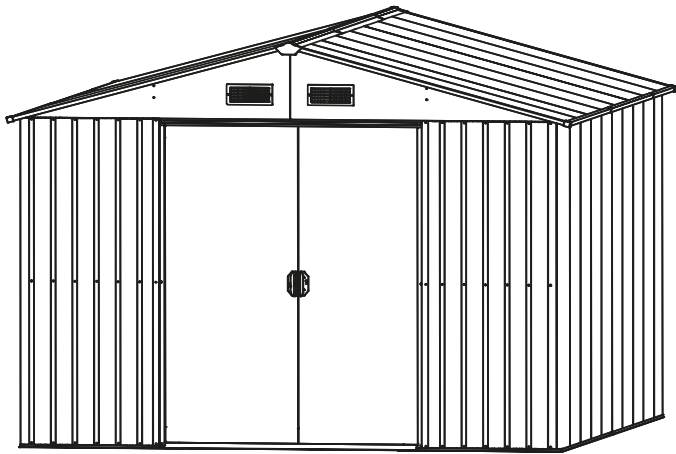

¡Enhorabuena!

Congratulations!

Félicitations !

Parabéns!

Herzliche Glückwünsche!

Thank 
you and
congratulations!





 **Hoggar**[®]

..... hoggargarden.com



OKORU GLOBAL S.L. // Pol. Ind. Barros^o 29.39408 Barros, Cantabria - España
(+34) 942 842 170 · info@okorues // MADE IN P.R.C.